

Report

WCC Marine Assets Structural Condition Assessment 2017

Prepared for Wellington City Council

Prepared by Beca Limited

29 March 2018



Revision History

Revision N°	Prepared By	Description	Date
0	Ronald Wessel/Calum Pringle	Final Issue	29 March 2018

Document Acceptance

Action	Name	Signed	Date
Prepared by	Ronald Wessel/Calum Pringle		29/03/2018
Reviewed by	Henry Tatham/Sharon Durno		29/03/2018
Approved by	Brian Smith		29/03/2018
on behalf of	Beca Limited		

© Beca 2018 (unless Beca has expressly agreed otherwise with the Client in writing).

This report has been prepared by Beca on the specific instructions of our Client. It is solely for our Client's use for the purpose for which it is intended in accordance with the agreed scope of work. Any use or reliance by any person contrary to the above, to which Beca has not given its prior written consent, is at that person's own risk.

Executive Summary

Beca Limited (Beca) was commissioned by Wellington City Council (WCC) to complete general visual condition assessments of 10 No. marine assets in the area of Evans Bay and the Miramar coast. The purpose of these assessments was to report on the condition of the above and below water structural elements of the assets. The following key observations for the assessed structures were made and recommendations provided:

Seatoun Wharf

The piles which are concrete encased appeared to be in a better condition than the timber piles completely exposed to seawater, in particular within the tidal zone, resulting in significant rot, cross section loss and splitting of the exposed piles.

It was observed that previous pile repairs comprising sistering of timber joists to existing timber piles stopped short of being embedded into the marine bed. These instead beared on concrete encased pile sockets above marine bed level. Therefore, these pile repairs were not considered to be providing continuity across the weakened pile section. Hinging of these sistered piles in conjunction with severely deteriorated timber bracing may have led to a lateral shunting of the ferry landing platform piles which was observed.

In light of the shunting and inclination of the timber piles observed, it appears the lateral stability of the landing platform to cater for ferry mooring loads is compromised. Repair of existing or installation of replacement piles with adequate embedment into the marine bed, along with new timber bracing supporting and restraining the landing platform, should be considered.

Furthermore, white rot was encountered on one of the bearers supporting the landing platform. No other signs of distress to this bearer were observed. However, it is recommended that the white rot is treated to stop it spreading and a timber sample is taken to check the penetration of the rot. Further assessment of the condition of the joist can result from this sampling.

Finally, all the bolted connections showed advanced deterioration due to corrosion and should be replaced as part of wharf maintenance.

Cog Park Jetty

Most piles were found to be significantly compromised having lost most or even in some instances the complete pile cross section. It is recommended that pile strengthening or replacement is carried out within the next 6 months.

Greta Point Wharf

The timber structure was found overall to be in a reasonable condition. Only in very few instances splitting at the ends of decking joists was encountered. Furthermore, the horizontal and diagonal bracing was, in several instances, in a poor or very poor condition, with significant rot and splitting having occurred causing significant cross-sectional losses. In these cases, replacement of timber bracing will be required within the next 12 months.

The bolted steel connections were found to be significantly corroded with the onset of delamination of the bracket plates. It is recommended that in the mid to longer-term (within 24 months), the steel connections are replaced.

Evans Bay Yacht Club Northern Jetty

Several of the piles were found to be in a poor or very poor condition either by having lost a significant portion of cross section or having been weakened by rot hollowing out the pile combined with significant splitting. In these cases, replacement or strengthening of the piles would be recommended within the next 12 months.

Cracking at in-situ concrete stitch pours between deck units was also observed, but could be addressed by re-grouting in the course of scheduled maintenance.

Evans Bay Yacht Club Southern Jetty

Similar to the northern jetty, most piles were found significantly weakened by cross section loss. Furthermore, the concrete decking also appeared to be in a poor condition with extensive cracking of the decking soffit and localised spalling encountered. Selective replacement of piles and decking within the next 24 months is recommended.

Cog Park Boat Ramp

The boat ramp was found in an overall good condition with the onset of marine growth and bolted connections showing the onset of surface rust. Therefore no immediate maintenance actions are suggested.

Evans Bay Yacht Club Northern Jetty

Several of the piles were found to be in a poor or very poor condition either by having lost a significant portion of cross section or having been weakened by rot hollowing out the pile combined with significant splitting. In these cases, replacement or strengthening of the piles is recommended within the next 12 months.

Cracking at in-situ concrete stitch pours between deck units was also observed, but could be addressed by re-grouting in the course of scheduled maintenance.

Evans Bay Yacht Club Southern Jetty

Similar to the northern jetty, most piles were found significantly weakened by cross section loss. The concrete decking also appeared to be in a poor condition with extensive cracking of the decking soffit and localised spalling encountered. Selective replacement of piles and decking within the next 24 months is recommended.

Evans Bay Yacht Club Travel Lift

The travel lift platforms were in a reasonable condition, except where cracking was observed at one of the intermediate pile locations, on the inside face of the northern travel platform. It is recommended, that these cracks should be monitored to confirm whether these are signs of distress resulting from ongoing use of the travel lift.

Also, the protective paint system of the steel beams supporting the traverse access platform has degraded substantially. It is recommended to remove any flaking paint and onset of rust and re-coat the steel beams.

Evans Bay Boat Ramp North Jetty

The Jetty was found in very good condition with only marine growth observed on piles and fenders.

Evans Bay Boat Ramp South Jetty

All the piles were found to be subject to cross section loss and extensive splitting at the top of the piles. Furthermore, swaying of the jetty was observed due to insufficient pile embedment into the marine bed.

Further defects comprised splitting of one of the end span joists leading to a piece of timber breaking off and a decking edging plank missing between the 2nd and 4th pile on the northern side of the decking, both of which are recommended to be replaced.

Karaka Bay Wharf

All intermediate piers were found in a good condition. However the pier piles at the end pier showed significant cross section loss due to rot and splitting, and replacement of these piles is recommended.

Furthermore, it is recommended to sister the remaining joists in the end span due to significant splitting at the ends.

Summary of Structural Elements Recommended for Urgent Attention

The condition ratings assigned to the structural elements of each asset range from 1 to 6. Dependent on the condition description, rating 6 does not always necessitate urgent remedial action. It is recommended that all elements assigned a rating 4 or 5 are considered for urgent remedial repair. The elements assigned a rating of 3, 4 or 5 (or a critical 6) from both the above and below water surveys are summarised in the table below.

Table 1-1 – Structural Elements in a Critical Condition

	Greta Point	Cog Park Boat Ramp	Cog Park Jetty	Yacht Club North	Yacht Club South	Yacht Club Travel Lift	Boat Ramp North	Boat Ramp South	Seatoun	Karaka Bay
Piles			All piles	A2, A5, B8, B9, B10, B11, B12, B14	A1, A2, A4, A5, B8, B9, B12			A2, A3, A4, A5, A6,	A1, A2, A8, A9, A10, A11, B1, B2, B5, B6, B9, B11, C2, C3, C4, D1, D2, D3, D4, E1, E3, E4,	C2, C1
Bearers/ Joists			All joists						A1-A4, A3-B3, D2-D4, C3-C4, C2-C3, D2-E2, C2-D2, D2-E2, C3-D3, D3-E3, C4-D4, D4-E4	All joists not currently sistered
Decking					Conc. slab	Traverse access platform			All timber on main pier	Timber grids 3, 4 and C. Chipseal surfacing

	Greta Point	Cog Park Boat Ramp	Cog Park Jetty	Yacht Club North	Yacht Club South	Yacht Club Travel Lift	Boat Ramp North	Boat Ramp South	Seatoun	Karaka Bay
Bracing	A8/B9, A7/B10, A5/B12, A4/B13, A3/B14								All bracing on landing platform	
Connections	All		All	All	All			All	All	End pier
Fenders										

Contents

1	Introduction.....	1
1.1	Scope of Assessment.....	1
1.2	Assessment Methodology.....	1
1.3	Limitations.....	2
1.4	Asset Locations.....	2
1.5	Report Format.....	5
2	Greta Point Wharf.....	6
2.1	General Description.....	6
2.2	Condition Assessment.....	7
2.3	Above Water Inspection Notes.....	10
2.4	Underwater Inspection Summary.....	11
3	Cog Park Boat Ramp.....	12
3.1	General Description.....	12
3.2	Condition Assessment.....	13
3.3	Above Water Inspection Note.....	14
3.4	Underwater Inspection Summary.....	14
4	Cog Park Jetty.....	15
4.1	General Description.....	15
4.2	Condition Assessment.....	16
4.3	Above Water Inspection Notes.....	21
4.4	Underwater Inspection Summary.....	22
5	Evans Bay Yacht Club, North Jetty.....	23
5.1	General Description.....	23
5.2	Condition Assessment.....	24
5.3	Above Water Inspection Notes.....	29
5.4	Underwater Inspection Notes.....	30
6	Evans Bay Yacht Club, South Jetty.....	31
6.1	General Description.....	31
6.2	Condition Assessment.....	32
6.3	Above Water Inspection Notes.....	36
6.4	Underwater Inspection Notes.....	37
7	Evans Bay Yacht Club Travel Lift.....	38
7.1	General Description.....	38
7.2	Condition Assessment.....	39
7.3	Above Water Inspection Notes.....	42
7.4	Underwater Inspection Notes.....	42

8	Evans Bay Boat Ramp, North Jetty	43
8.1	General Description	43
8.2	Condition Assessment	44
8.3	Above Water Inspection Notes	46
8.4	Underwater Inspection Notes	46
9	Evans Bay Boat Ramp, South Jetty	47
9.1	General Description	47
9.2	Condition Assessment	48
9.3	Above Water Inspection Notes	51
9.4	Underwater Inspection Notes	51
10	Seatoun Wharf	52
10.1	General Description	52
10.2	Condition Assessment	53
10.3	Above Water Inspection Notes	61
10.4	Underwater Inspection Notes	64
11	Karaka Bay Wharf	65
11.1	General Description	65
11.2	Condition Assessment	66
11.3	Above Water Inspection Notes	74
11.4	Underwater Inspection Notes	75

Appendices

Appendix A

Underwater Solutions' Pile Inspection Report

1 Introduction

Beca Limited (Beca) has been commissioned by Wellington City Council (WCC) to complete general condition assessments of 10 No. marine assets in the area of Evans Bay and the Miramar coast.

The purpose of these assessments was to report on the condition of the above and below water asset structural elements.

The assessed assets were as follows:

- Greta Point Wharf
- Cog Park Boat Ramp
- Cog Park Jetty
- Evans Bay Yacht Club, North Jetty
- Evans Bay Yacht Club, South Jetty
- Evans Bay Yacht Club Travel Lift
- Evans Bay Boat Ramp, North Jetty
- Evans Bay Boat Ramp, South Jetty
- Seatoun Wharf
- Karaka Bay Jetty.

1.1 Scope of Assessment

The scope of these assessments was as follows:

- Carry out visual inspections of the above-water structures to determine the general condition of members and connections, and identify any parts of the structure that require maintenance, repair or reinstatement.
- Carry out inspections of the below-water structures, using a dive team from Underwater Solutions Limited, to determine the general condition of members and connections, and identify any parts of the structure that require maintenance, repair or reinstatement.
- Provide a report outlining the findings of the condition assessment inspection for WCC, including a qualitative condition rating of the structural elements.

1.2 Assessment Methodology

The methodology adopted for both the below and above-water inspections was to systematically visually assess each structural element of the structures and assign them a numbered condition rating based on the rating descriptions of Table 1-1. Each element was documented in notes taken on site with a description of their condition and their assigned condition rating (refer section tables).

Table 1-1. Condition Rating Descriptions

Rating	1	2	3	4	5	6
Description	No Visible damage/ decay, or minor damage with minor surface rot visible.	Less than 10% reduction in cross-section from original. Some extent of rot visible.	10-30% reduction in cross-section from original. Moderate extent of rot visible.	30-60% reduction in cross-section from original. Extensive not visible.	Greater than 60% reduction in cross-section from original. Rot likely penetrated full cross-sectional extent of pile.	Additional damage/ decay not covered by condition ratings 1-5. Comments/ notes included

1.3 Limitations

The following limitations apply to this commission:

- No drilling/core samples were taken from the structures. The inspections were of a visual nature only.
- No structural calculations were undertaken. We have provided a qualitative assessment only.

1.4 Asset Locations

The various marine structures inspected are located around the western shore of Evans Bay and on the eastern Miramar coast. The following figures identify the locations of each asset.



Figure 1-1. Asset Locations, Greta Point Wharf, Cog Park Boat Ramp, Cog Park Jetty



Figure 1-2. Asset Locations, Evans Bay Yacht Club (various), Evans Bay Boat Ramp (various)



Figure 1-3. Asset Location, Seatoun Wharf

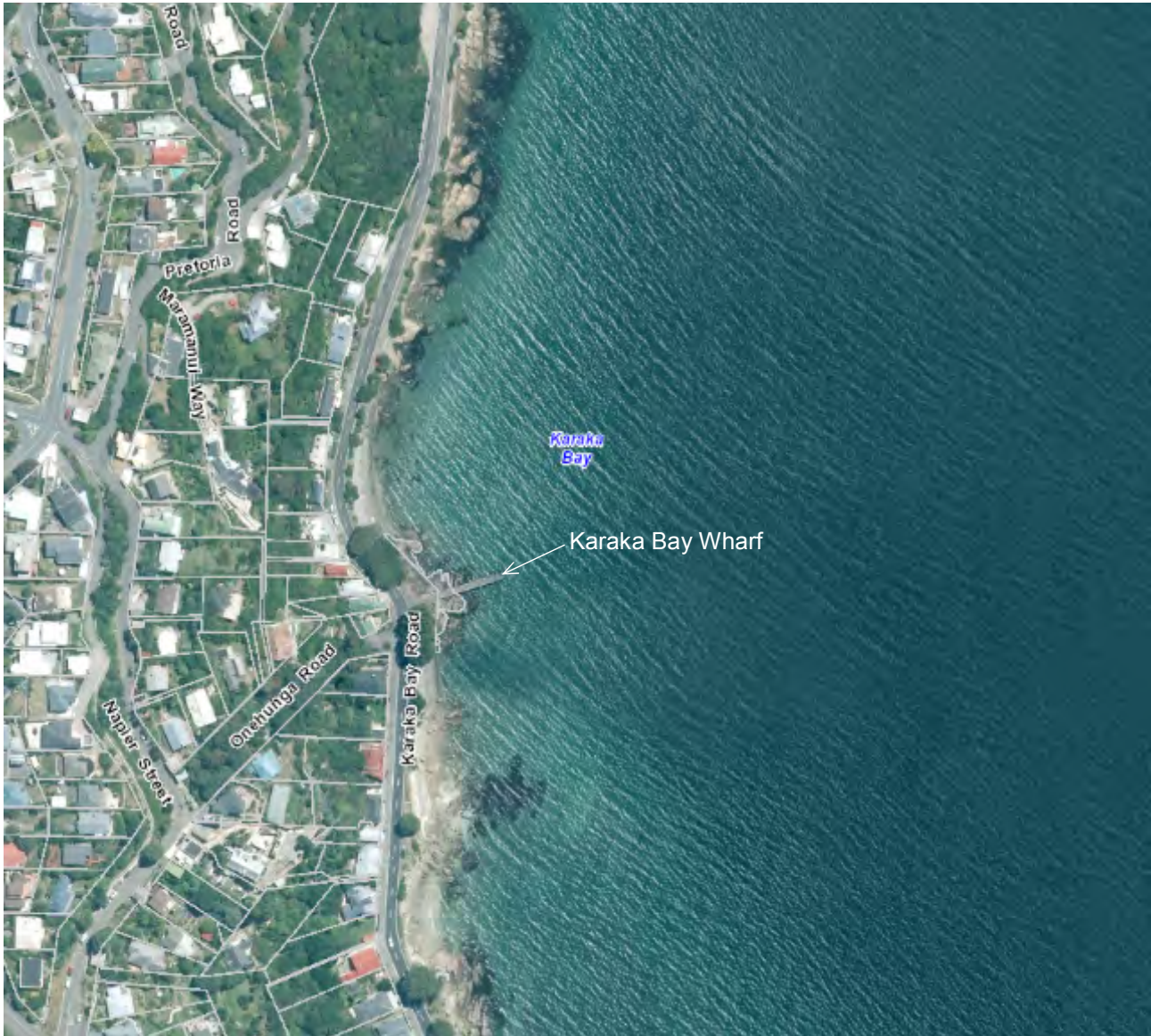

Figure 1-4. Asset Location, Karaka Bay Wharf

1.5 Report Format

This report is formatted such that each asset description, condition assessment, any recommendations and plan are self-contained in individual sections.

Note – refer Appendix A for Underwater Solutions' below water pile inspection report.

2 Greta Point Wharf

2.1 General Description

Greta Point Wharf is a timber structure. It comprises two rows of timber support piles (8no. pairs), with cross bracing on the seaward 5no. pairs. Pile bearers support 3no. joists running the length of the structure (two along either edge and one centrally mounted) which support the timber decking. Diagonally mounted timber fenders run the length of both sides of the wharf, fixed at their top to the timber joists and toward their base to timber beams which are fixed just above the low water line to the piles. Timber kick boards are present along either edge of the top of the decking. The timber elements are held together with steel nails, bolts and connections, many of which are corroded.

The wharf is 1.55m wide and approximately 39m long.



Figure 2-1. Greta Point Wharf General Arrangement

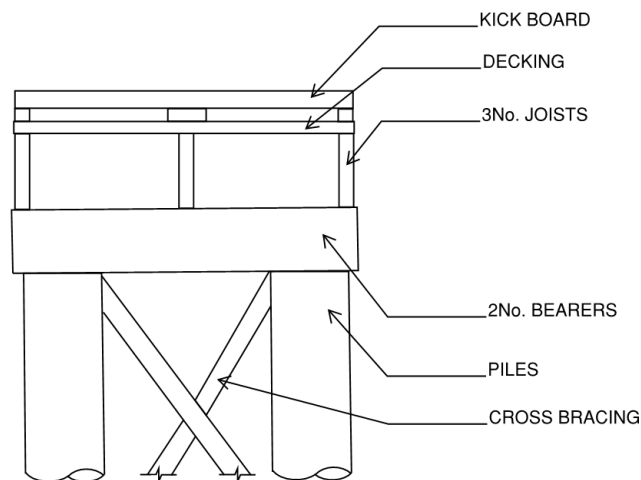

Figure 2-2 – Greta Point Wharf End Elevation Detail

2.2 Condition Assessment

2.2.1 Piles

The piles were visually inspected both above and below water. Refer to Appendix A for details of the underwater visual assessment and Table 2-2 for a summary of the pile conditions. The piles were found to be in a reasonable condition both above and below water without the need for immediate maintenance actions. Refer to Figure 2-3 for a typical pile example.



Figure 2-3. Greta Point Wharf - Typical Condition of Piles

2.2.2 Bearers and Joists

All timber decking joists and bearers were found overall in a reasonable condition. Only in very few instances was splitting at the ends of decking joists encountered as illustrated in Figure 2-4.

In these instances it would be recommended to replace the timber joists.



Figure 2-4. Greta Point Wharf - Splitting of Joist

2.2.3 Decking

All timber decking was found to be in a good condition, refer to Figure 2-5, without the need for immediate maintenance actions.



Figure 2-5. Greta point wharf – Decking

2.2.4 Bracing

The horizontal and diagonal bracing was, in several instances, in a poor or very poor condition as shown in Figure 2-6. With significant rot and splitting having occurred causing significant cross-sectional losses. In these cases, replacement of timber bracing will be required within the next 12 months.



Figure 2-6. Greta Point Wharf – Deteriorated Pile Bracing

2.2.5 Connections and Bolts

Figure 2-7 shows the bolted steel connections comprising bolts with nuts and washers, and steel brackets being subject to significant corrosion with the onset of delamination of the bracket plates. It is recommended that in the mid to longer-term (within 24 months) the steel connections are replaced before the condition of the connections deteriorates such that the structural integrity of the wharf is compromised.



Figure 2-7. Greta Point Wharf – Advanced Corrosion of Bolted Connections

2.2.6 Fenders

All timber fenders were found to be in a good condition without the need for immediate maintenance actions.

2.3 Above Water Inspection Notes

Table 2-1. Above Water Inspection Notes

Structure	Greta Point Wharf		
Date of Inspection	21/11/2017		
Time of Inspection	15:20		
Low Tide Time	1:20		
Grid Reference	Item Description	Condition Description	Condition Rating
	Connections - all	Significant corrosion	3
	Piles - all	Good condition	1
	Joists - all	Good condition	1
	Fenders - all	Some surface damage	2
	Beams - all	Good condition	1
	Bracing - horizontal	Some surface rot	2
	Bracing - Diagonal	Some marine growth and decay	3
	Toe rails	Damage and splitting	2
	Deck slats	Some minor damage and splitting	1 to 2
	Steel bracket connections	Significant corrosion	3
A8/B9	Diagonal Bracing	Marine growth and decay - completely eroded at connection to A8	5
A7/B10	Diagonal Bracing	Some surface decay - completely eroded at connection to B10	4
A5/B12	Diagonal Bracing	Marine growth and decay - almost completely eroded at connection to pile	4
A5/B12	East joist	Splitting - localised	2
A4/B13	Diagonal Bracing	Marine growth and decay - almost completely eroded at connection to pile	4
A3/B14	Diagonal Bracing	Marine growth and decay - completely eroded at connection to B14	5

2.4 Underwater Inspection Summary

Table 2-2. Underwater Inspection Notes

Pile Number	Condition Rating	Pile Number	Condition Rating
1	1	9	1
2	1	10	1
3	1	11	1
4	1	12	1
5	1	13	1
6	1	14	1
7	1	15	1
8	1	16	1

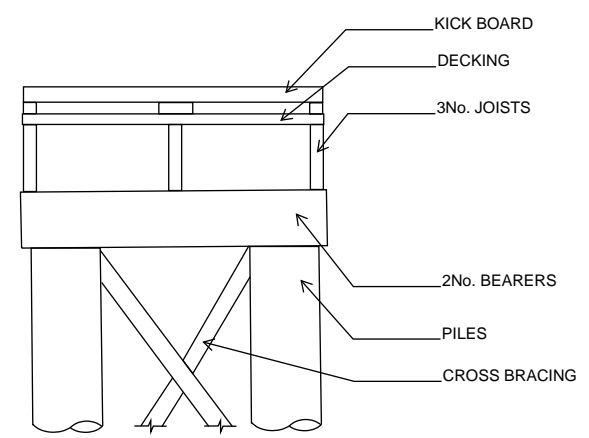
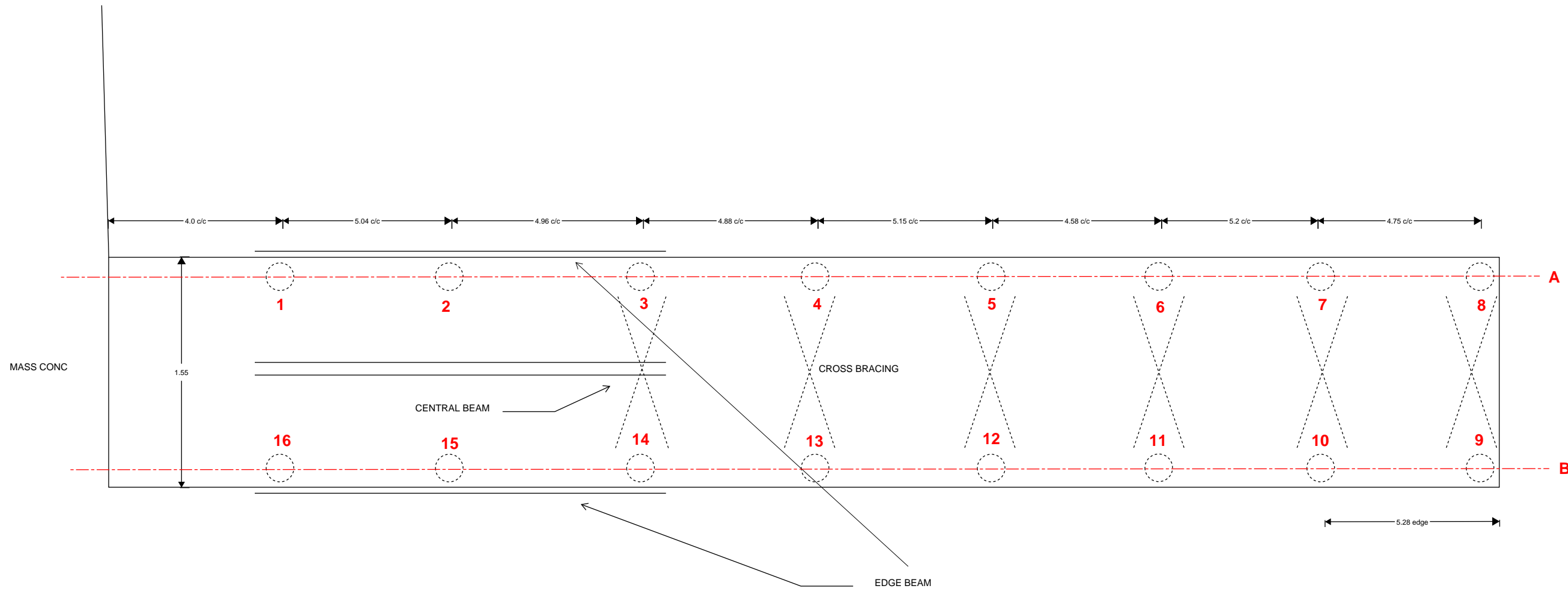

PDF ONLY
NO DWG FILE

No.	Revision	By	Chk	Appd	Date
A	FOR INFORMATION	CP			11.17



Original Scale (A1)	Design	Approved For Construction*
Reduced Scale (A3)	Drawn	Date
	Dwg Verifier	
	Dwg Check	
* Refer to Revision 1 for Original Signature		

Client: WELLINGTON CITY COUNCIL

Project: WCC WHARF STRUCTURAL INSPECTIONS

Title: GRETA POINT

Discipline	MARINE STRUCTURAL
Drawing No.	3320740-SE-K100
Rev.	A

3 Cog Park Boat Ramp

3.1 General Description

Cog Park Boat ramp is a timber structure. The structure is made up of 5no. pairs of timber support piles with 2no. bearers per pair supporting 7no. joists running the length of the boat ramp supporting the timber decking. The easterly 4no. sets of piles have cross bracing between them and the landward end of the boat ramp is secured in a concrete foundation. The timber decking is topped with grip rungs to either side of a length of central strakes, with kick boards running the length of the ramp to either side of the grip rungs.

The boat ramp is 3.55m wide and approximately 28m long in plan.



Figure 3-1 – Cog Park Boat Ramp General Arrangement

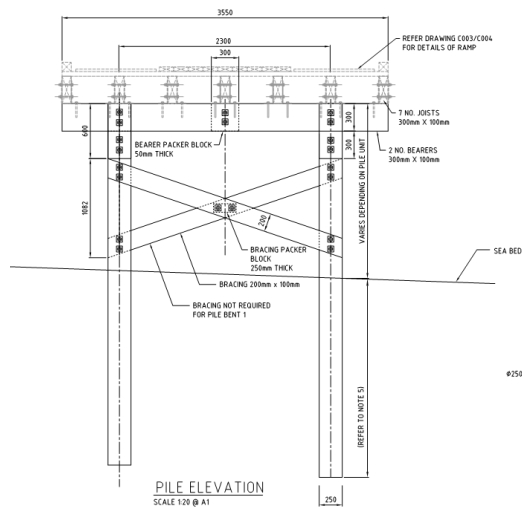

Figure 3-2 - Cog Park Boat Ramp End Elevation Detail

3.2 Condition Assessment

3.2.1 Piles

The piles were inspected visually below water and above water level subject to access. Refer to Appendix A for details of the underwater visual assessment and Table 3-2 for a summary of the pile conditions. The piles were found to be in a good condition both above and below water without the need for immediate maintenance actions.

3.2.2 Joists and Decking

Both the joists and decking appeared to be in a reasonable condition with the typical onset of sea weed coverage and marine growth within the tidal zone. Refer Figure 3-3 below.



Figure 3-3. Cog Park Boat Ramp – Decking and Joist in Good Condition

3.2.3 Connections and Bolts

With the boat ramp being constructed in 2007, the bolted connections that could be visually assessed appeared to be in a reasonable condition with only the onset of surface rust. Refer to Figure 3-4. Therefore no further maintenance actions are suggested.



Figure 3-4. Cog Park Boat Ramp, Bolted Connections

3.3 Above Water Inspection Note

Table 3-1. Above Water Inspection Notes

Structure	Cog Park Boat Ramp		
Date of Inspection	21/11/2017		
Time of Inspection	3:10		
Low Tide Time	1:20		
Grid Reference	Item Description	Condition Description	Condition Rating
N/A	General structure	All timber and connection observed was in good condition. Structure relatively new - built in 2007.	1
Grid A	Concrete slab at shore abutment	Localised undermining of slab to North side	2
Tide on structure at mid-level			

3.4 Underwater Inspection Summary

Table 3-2. Underwater Inspection Notes

Pile Number	Condition Rating	Pile Number	Condition Rating
1	1	6	1
2	1	7	1
3	1	8	1
4	1	9	1
5	1	10	1

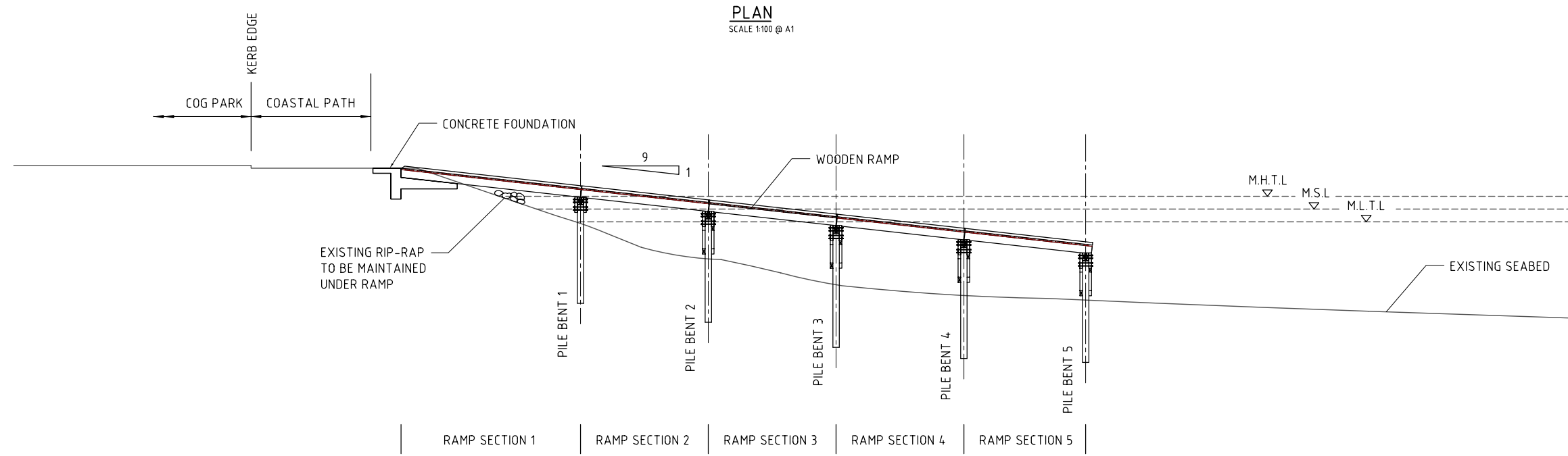
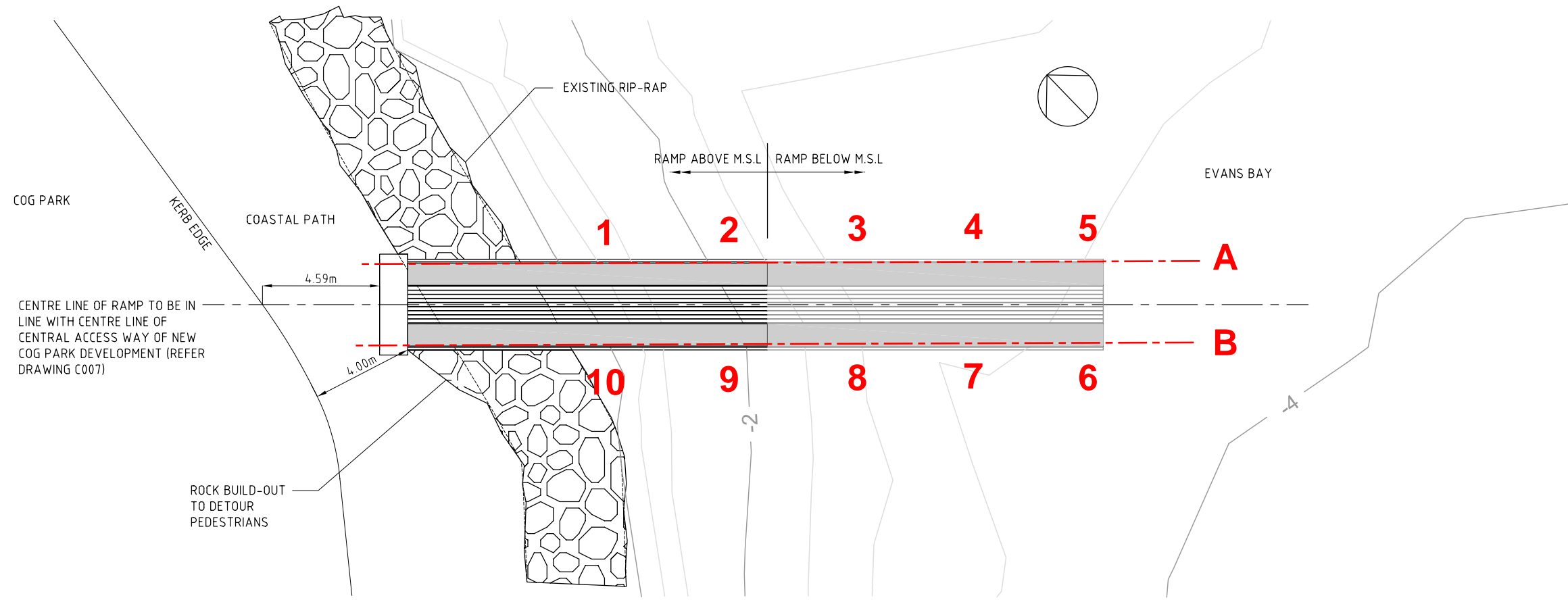

	DATUM 0.00m										
RAMP DIMENSIONS	0.00	1.20	8.21	13.21	18.21	23.21	27.97				
EXISTING GROUND	+1.7		0.0	-0.5	-1.0	-1.5	-2.0	-2.5	-3.0	-3.5	-4.0
DISTANCE FROM KERB EDGE	0.00		11.17	12.70	14.03	15.27	18.43	20.72	23.12	31.24	43.61

No.	Revision	By	Chk	Appd	Date
1	FOR CONSTRUCTION	WZC	VH	PBS	16.07.07
0A	FOR BUILDING CONSENT	WRM	PBS	PBS	22.06.07
0	FOR TENDER	WRM	PBS	PBS	10.04.07

Drawing Originator: **BECA** Engineers = Planners = Managers

Original Scale (A1)	Design	WRM	28.02.07	Approved For Construction*
AS SHOWN	Drawn	WRM	06.03.07	PBS
Reduced Scale (A3)	Dwg Verifier	VH	16.07.07	
1/2 SHOWN	Dwg Check	WRM	16.07.07	Date 16.07.07

* Refer to Revision 1 for Original Signature

Client: **Absolutely POSITIVELY Wellington**

Project: **COG PARK BOAT RAMP**

Title: **GENERAL LAYOUT**

FOR CONSTRUCTION

Discipline: **CIVIL**

Drawing No. **3320324-C001**

Rev. **1**

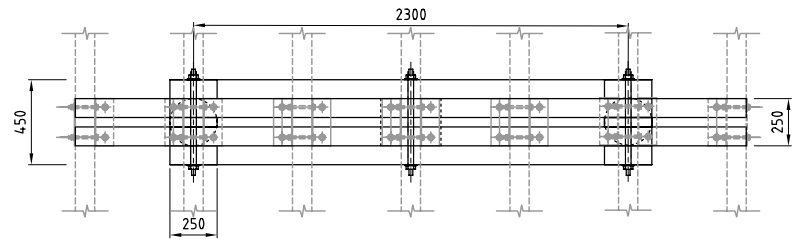

PILE PLAN
SCALE 1:20 @ A1

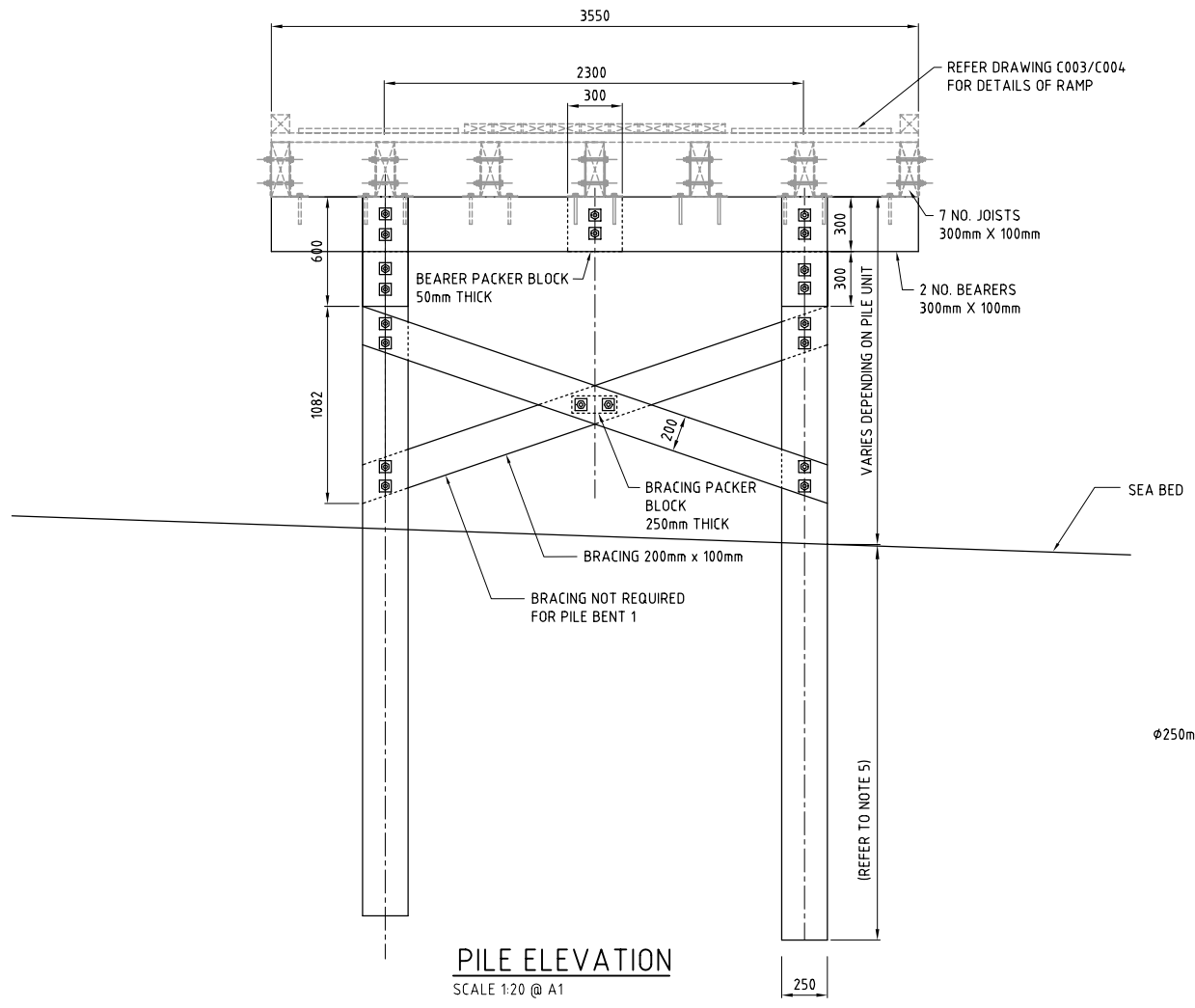

PILE ELEVATION
SCALE 1:20 @ A1

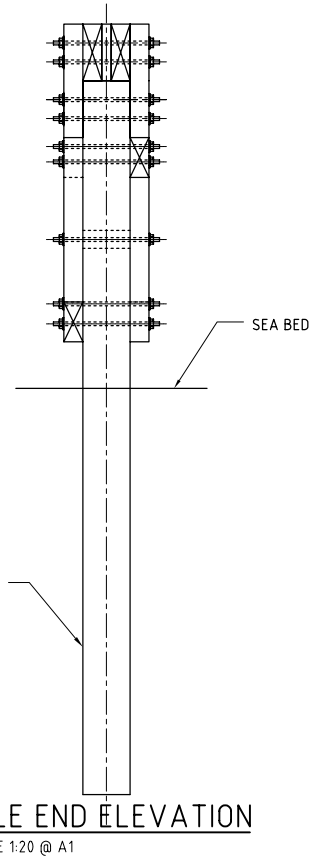

PILE END ELEVATION
SCALE 1:20 @ A1

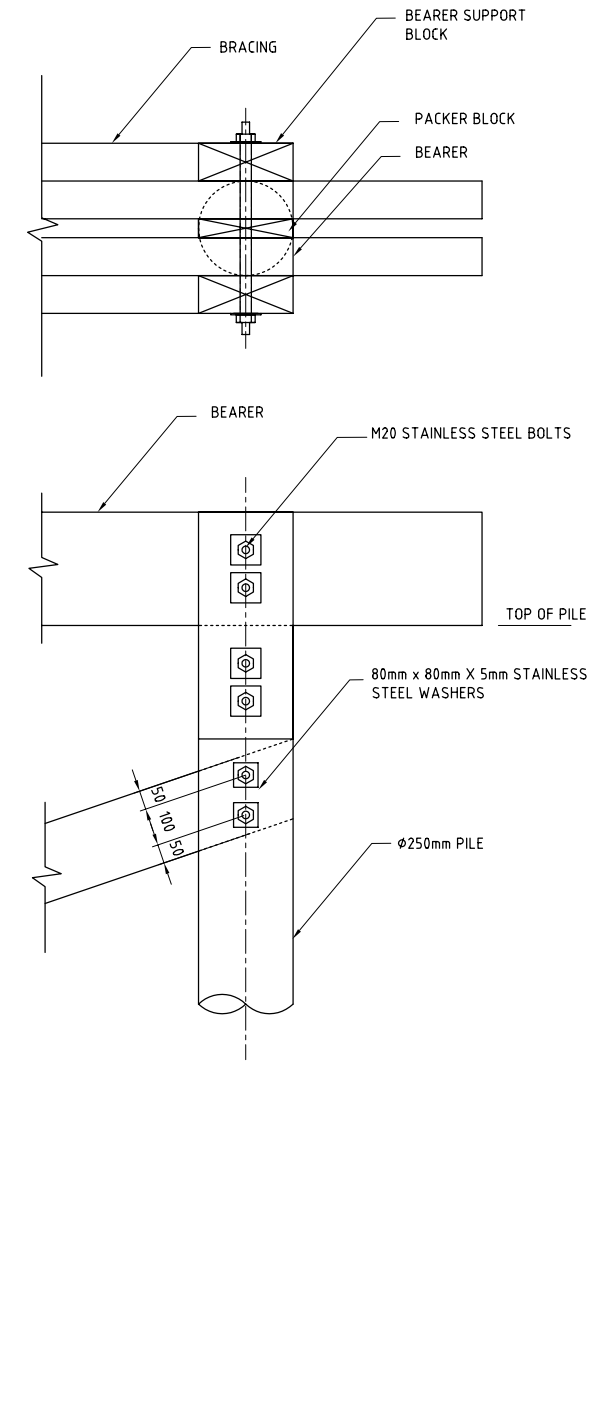

PILE DETAIL
SCALE 1:10 @ A1

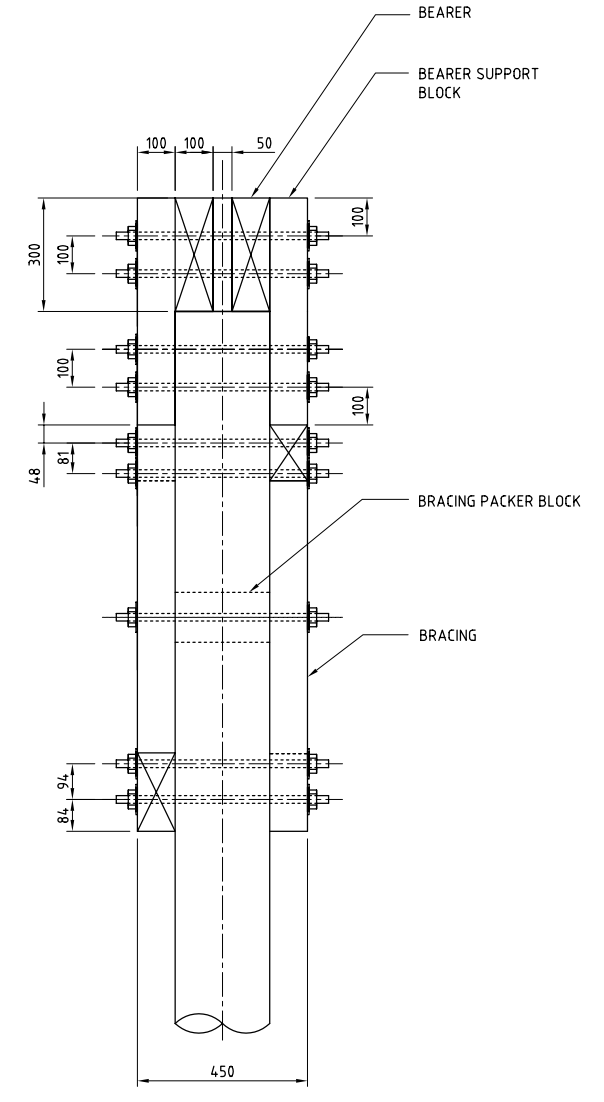

NOTES:

1. ALL TIMBER TO BE ENGINEERING GRADE RADIATA PINE TREATED H6. ANY SURFACES CUT AFTER TREATMENT TO BE GIVEN AN APPROVED PROTECTED COATING.
2. ALL TIMBER TO BE ROUGH SAWN WITH THE BEARERS AND JOISTS DEPTHS GAUGED.
3. TIMBER WORK TO COMPLY WITH NZS 3606.
4. ALL BOLTS AND FITTINGS TO BE STAINLESS STEEL.
5. PILES TO BE DRIVEN TO A SPECIFIED SET TO ACHIEVE A SAFE WORKING LOAD OF 35KN CALCULATED USING THE HILEY FORMULA, PILES TO BE REDRIVEN AFTER AT LEAST 24 HOURS TO CONFIRM SET. PILES TO BE DRIVEN AT LEAST 2m INTO THE SEABED.
6. PILES TO BE 250mm SED (SMALL END DIAMETER).

No.	Revision	By	Chk	Appd	Date
1	FOR CONSTRUCTION	WZC	VH	PBS	16.07.07
0A	FOR BUILDING CONSENT	WRM	PBS	PBS	22.06.07
0	FOR TENDER	WRM	PBS	PBS	10.04.07

Drawing Originator:
Engineers = Planners = Managers

Original Scale (A1) AS SHOWN	Design	Drawn	Date	Approved For Construction*
1/2 SHOWN	WRM	WRM	28.02.07	PBS
	Dwg Verifier	VH	06.03.07	
	Dwg Check	WRM	16.07.07	

* Refer to Revision 1 for Original Signature

Client:

Project: **COG PARK BOAT RAMP**

Title: **PILE STRUCTURE**

Discipline	Rev.
CIVIL	1
Drawing No. 3320324-C002	

FOR CONSTRUCTION

4 Cog Park Jetty

4.1 General Description

Cog Park Jetty is a timber and concrete structure. The structure appears to comprise 2no. primary sections: a large plan 'square' section adjacent to the land with a protruding thinner jetty seaward.

The thin jetty is made up of a single row of timber support piles, with a pair of piles at the seaward end for lateral stability, with bearers spanning the breadth of the jetty. The piles and bearers support 3no. joists, running the length of the thin jetty, topped with precast concrete deck slabs. Kick boards run along either top edge of the concrete slabs.

The large 'square' section of the jetty structure also comprise timber piles and bearers. There are 2no. rows of piles (5no. in total – 3no. on the northern side and 2no. on the eastern side). There are 2no. sets of bearers connected to the seaward pair of piles (one on top of the other). The upper set of bearers support approximately 7no. timber joists which in-turn support the insitu poured concrete deck (reinforcement unknown).

The larger 'square' deck is 4.75m wide and 6.1m long on the southern side. The longer thinner part of the jetty is 1.42m wide and approximately 12m long.



Figure 4-1. Cog Park Jetty General Arrangement

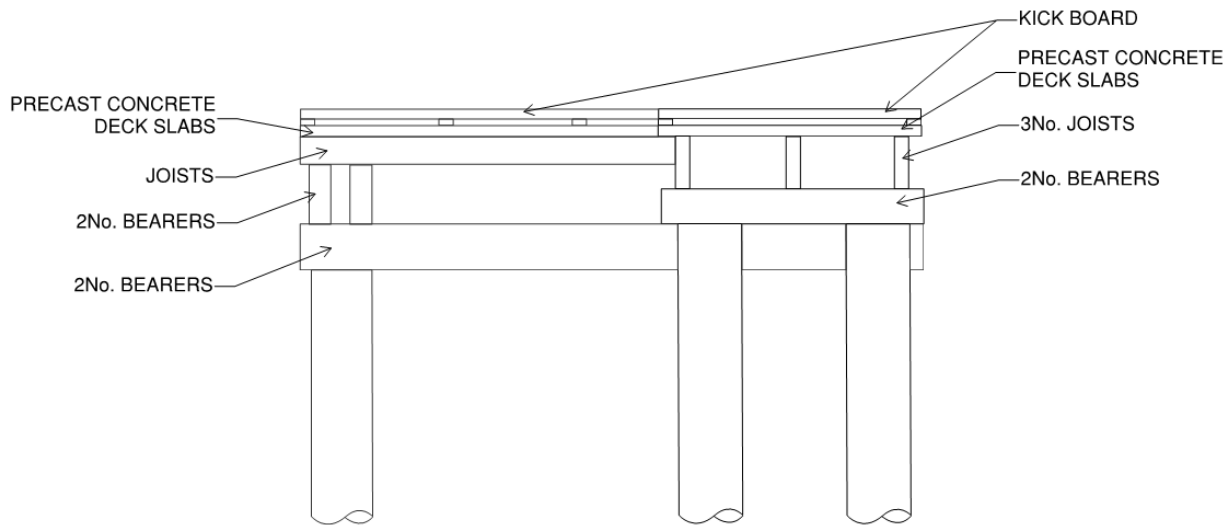

Figure 4-2 – Cog Park Jetty End Elevation Detail

4.2 Condition Assessment

4.2.1 Piles

The piles were inspected visually both above and below water. Refer to Appendix A for details of the underwater visual inspection and Table 4-2 for a summary of the pile conditions. Above water, most piles were assessed in either a poor or very poor condition which was further confirmed by findings of the underwater inspection. In some instances timber piles have lost most or even the complete cross section which in some instance could only be observed under water, thus not visible from above water level. Refer to Figure 4-3 for typical piles.



Figure 4-3. Cog Park Jetty, Piles Cross Section Loss and Splitting

Based on these observations, the integrity of the jetty is severely compromised and it is recommended that immediate remedial options are considered.

4.2.2 Joists

The joists showed a moderate extent of rot and splitting, in particular at the ends as illustrated in Figure 4-4 and Figure 4-5.



Figure 4-4. Cog Park Jetty – Representative View of All Joist



Figure 4-5. Cog Park Jetty – Observed Splitting of Ends of Bearers

4.2.3 Deck

The concrete deck was considered to be in a reasonable condition, as illustrated in Figure 4-6. The sacrificial soffit steel formwork was severely corroded, see Figure 4-7, however without any noticeable consequence to the performance of the deck, which showed no signs of distress such as cracking.



Figure 4-6. Cog Park Jetty - Top View on Concrete Deck



Figure 4-7. Cog Park Jetty - Underside View of Concrete Deck With Advanced Corrosion of Steel Soffit Formwork

4.2.4 Bracing and Connections

The condition of the bracing was considered reasonable compared to the condition of the bolted connections that fasten the bracings, joists and bearers; these showed signs of advanced corrosion and the onset of cross section loss in the washer plates, bolt heads and nuts. It is recommended that, in the long term, the connections are considered for replacement.



Figure 4-8. Plan Bracing of Decking in a Reasonable Condition



Figure 4-9. Bolted Connections

4.2.5 Fenders and other Miscellaneous Components

The tyre fenders in Figure 4-10 were found in a reasonable condition; however, it is suggested that WCC review whether the number and position of tyres are adequate subject to the use of the jetty.



Figure 4-10. Cog Park Jetty – Tyre Fenders

The access ladder in Figure 4-10 showed advanced signs of corrosion, but no signs of severe deterioration compromising the structural integrity of the ladder.

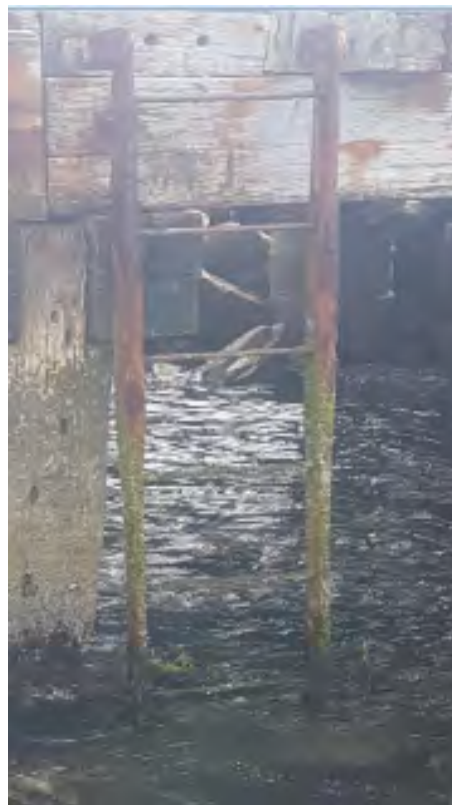

Figure 4-11. Access Ladder

The rotating derek hoist supports in Figure 4-12 showed significant corrosion within the tidal zone. The condition of the hoist supports may be secondary considering the derek hoists are fastened together, which suggests that these supports are not in use.



Figure 4-12. Cog Park Jetty - Derek Hoists

4.3 Above Water Inspection Notes

Table 4-1. Above Water Inspection Notes

Structure	Cog park Jetty		
Date of Inspection	21/11/2017		
Time of Inspection	2:50		
Low Tide Time	1:20		
Grid Reference	Item Description	Condition Description	Condition Rating
	All connections	Significant corrosion	3
C8	Pile	Cross section reduction - hole in north side	3
A4	Pile	Splitting on surface	3
B7	Pile	Significant splitting in surface	4
B6	Pile	Large hole in tidal zone	5
B5	Pile	Loss of cross section	3
D9	Pile, concrete	Loss of cross section	3
	Concrete deck cast on metal sheeting	Heavily corroded sacrificial metal sheeting. Concrete in ok condition	2
A3	Pile	Significant loss of cross section	4
A2	Pile	Significant loss of cross section	4
A1	Pile - lower concrete casing, upper timber	Concrete is ok, timber has significant rot and loss of cross section	4
	Joists - all	Splitting at ends where bolts are	3

4.4 Underwater Inspection Summary

Table 4-2. Underwater Inspection Notes

Pile Number	Condition Rating	Pile Number	Condition Rating
1	3	6	4
2	3	7	3
3	5	8	4
4	2	9	5
5	1	10	6

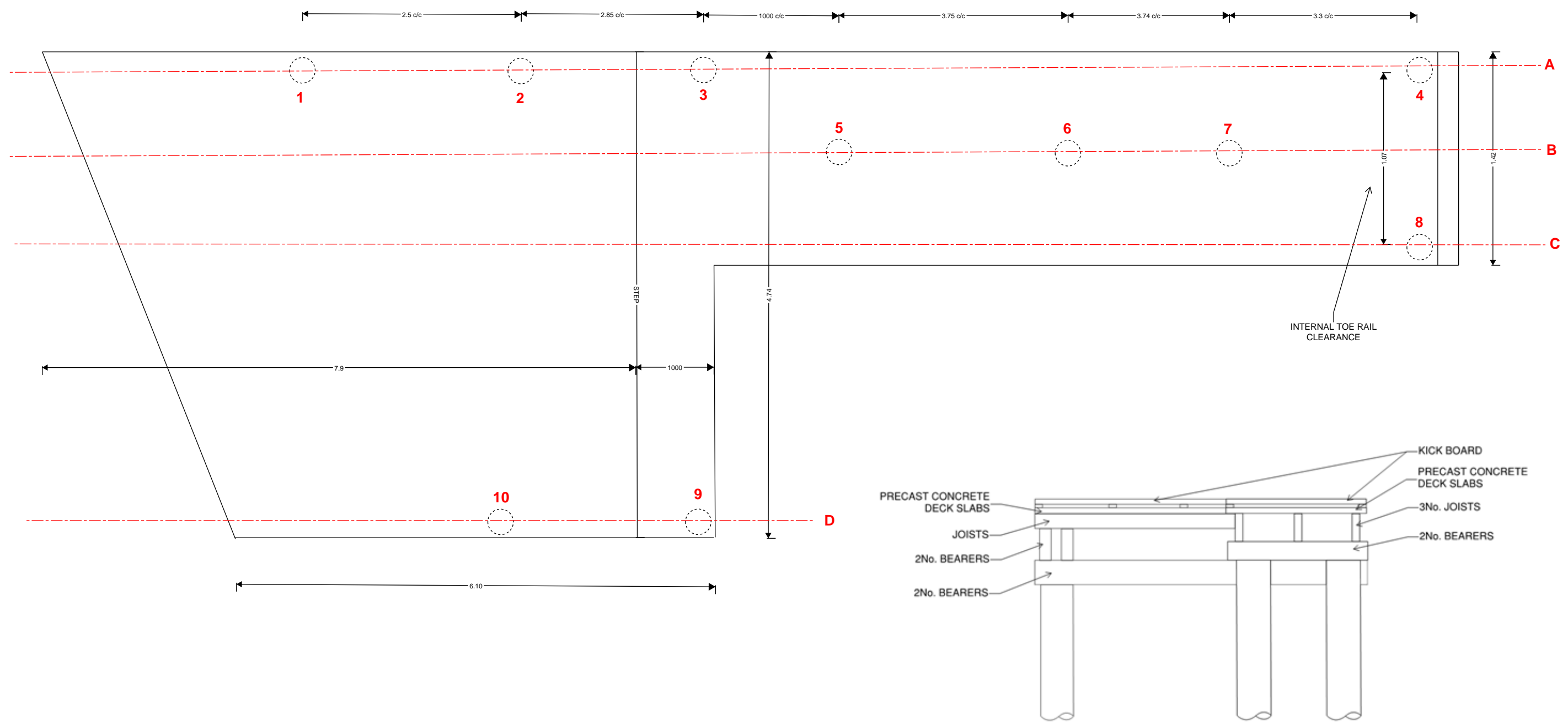

PDF ONLY
NO DWG FILE

FOR INFORMATION		CP	11.17
No.	Revision	By	Chk. Appl. Date



Drawing Originator:	Original Scale (A1)	Design	Approved For Construction*
Reduced Scale (A3)	Drawn	Design Verifier	Date
	Design Check		

* Refer to Revision 1 for Original Signature

Client: WELLINGTON CITY COUNCIL

Project: WCC WHARF STRUCTURAL INSPECTION

Title: COG PARK JETTY (HERITAGE)

Discipline: MARINE STRUCTURAL	Rev: A
Drawing No: 3320740-SE-K101	

5 Evans Bay Yacht Club, North Jetty

5.1 General Description

Evans Bay Yacht Club North Jetty is a timber and concrete structure. The jetty consists of 7no. pairs of timber piles, positioned outside the width of the deck, with timber bearers connected and directly supporting a precast concrete slab deck. The deck has kick boards running along either side of the deck top. On the north side of the jetty orientated perpendicular to it, there is a side jetty with a single support pile at its end. The other end of the side jetty is supported by a set of bearers connected to a support pile for the main jetty. The bearers are strengthened by diagonal bracing also connected to the main jetty support pile.

The jetty deck is 1.2m wide, the piles are approximately 2m c/c laterally and the jetty length is approximately 42.6m.



Figure 5-1 – Evans Bay Yacht Club North Jetty General Arrangement

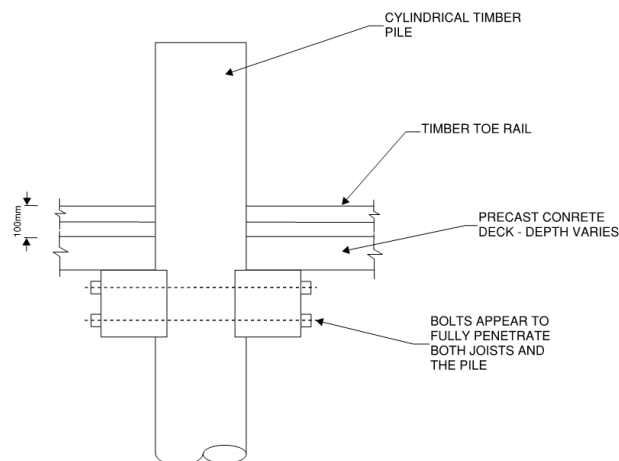

Figure 5-2 – Evans Bay Yacht Club North Jetty Pile Elevation Detail

Several of the piles were found to be in a poor or very poor condition either by having lost a significant portion of cross section or having been weakened by rot hollowing out the pile combined with significant splitting. In these cases, replacement or strengthening of the piles would be recommended within the next 12 months.

Cracking at in-situ concrete stitch pours between deck units was also observed, but could be addressed by re-grouting in the course of scheduled maintenance.

5.2 Condition Assessment

5.2.1 Piles

The piles were inspected visually both above and below water. Refer to Appendix A for details of the underwater visual inspection and Table 5-2 for a summary of the pile conditions. Above water several piles were found to be in a very poor condition either by having lost a significant portion of cross section or having been weakened by rot hollowing out the pile combined with significant splitting. Figure 5-3 shows to the left a typical pile with significant cross section loss and on the right a pile hollowed out by rot. It is recommended in the cases where the cross-sectional loss or rot within the piles is excessive that the piles are considered for strengthening or replacement.

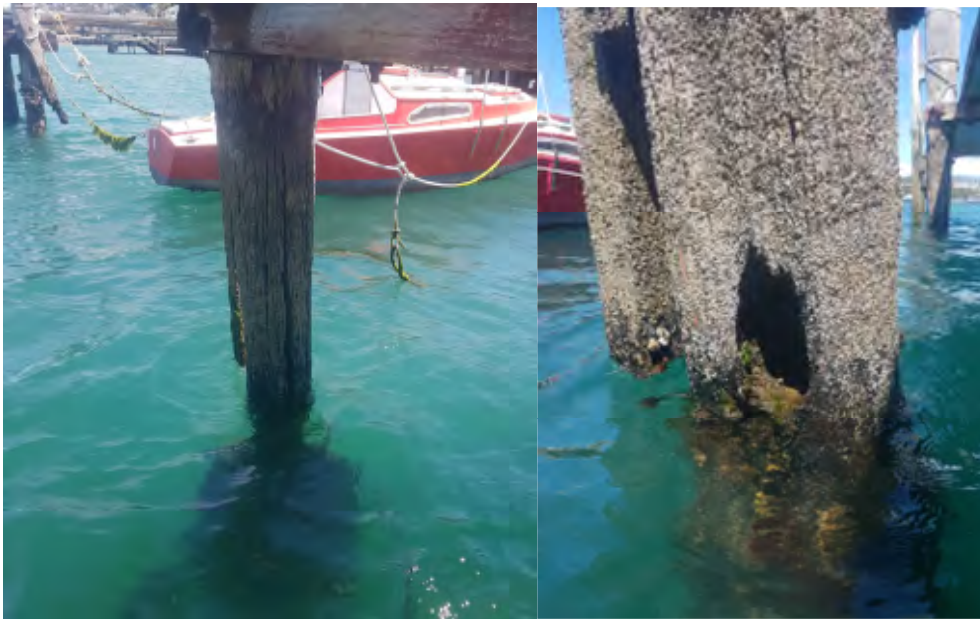

Figure 5-3. Evans Bay Yacht Club North Jetty - Pile Splitting, Rot and Cross Section Loss

5.2.2 Bearers and Connections

The bearers to the concrete deck were found to be in a reasonable condition, refer to Figure 5-4, with only the bearer mounted at the landward abutment in Figure 5-5 having undergone horizontal splitting from the bearer end face to the fastening.

Rust staining on the bearers illustrates the ongoing corrosion of the bolted connections fastening the bearers to the piles.



Figure 5-4. Evans Bay Yacht Club Northern Jetty, End Pier Bearer



Figure 5-5. Evans Bay Yacht Club Northern Jetty, End Bearer at Abutment

5.2.3 Decking

The slender concrete deck is suffering significant sagging as shown in Figure 5-6, but did not show any signs of cracking on the underside of the deck, refer Figure 5-7. However, cracking of the in-situ concrete stitch pour between deck units was observed, see Figure 5-8. This is not of major concern, and can be addressed by re-grouting in the course of scheduled maintenance.



Figure 5-6. Evans Bay Yacht Club Northern Jetty, Sagging of Decking



Figure 5-7. Evans Bay Yacht Club Northern Jetty - No Cracking Observed



Figure 5-8. Evans Bay Yacht Club Northern Jetty - Cracking of Concrete Decking Stitches

5.2.4 Fenders

The mooring fenders have experienced rot and some cross sectional losses within the tidal zone; however, this is less critical than the condition of the piles. Therefore, it would be recommended to replace the fenders in conjunction with the replacement of timbers at the end of their service life.



Figure 5-9. Evans Bay Yacht Club Northern Jetty, Fenders

5.2.5 Mooring Finger Jetty

The mooring jetty, shown in Figure 5-10, was prone to a significant amount of swaying which, as confirmed by an underwater visual inspection, was attributed to the mooring pile not being sufficiently embedded to prevent lateral movement.



Figure 5-10. Evans Bay Yacht Club Northern Jetty - Finger Jetty

5.3 Above Water Inspection Notes

Table 5-1. Above Water Inspection Notes

Grid Reference	Item Description	Condition Description	Condition Rating
Structure	Evans Bay Yacht Club North Jetty		
Date of Inspection	21/11/2017		
Time of Inspection	2:30		
Low Tide Time	1:20		
Grid Reference	Item Description	Condition Description	Condition Rating
A7	Pile	Some loss of cross-section	2
B8	Pile	Loss of cross-section	3
B9	Pile	Major splitting. Significant loss of cross section	4
A6	Pile	Marine growth and some rot. Fender broken	2
	Slabs precast	Good condition, chips in edging. No visible cracking. Joints poor.	Slab 1 Joints 2
A5	Pile	Significant splitting and loss of cross section	3
B10	Pile	Large hole just above water surface in tidal zone	5
A4 and B11	Piles	Some loss of cross section	2
B12	Pile	Significant splitting and hole in tidal zone	4
A3	Pile	Some loss of cross-section	2
A1	Pile	Some loss of cross-section	2
B14	Pile	Loss of cross section	3
A2	Pile	Significant rot and loss of cross section	4
B13	Pile	Evidence of boats scraping at top tidal mark	2
	Bolt connections - all	Minor corrosion - condition varies	2 to 3
	Support Beam at quay wall and connections	Some surface damage	2

5.4 Underwater Inspection Notes

Table 5-2. Underwater Inspection Notes

Pile No.	Condition Rating	Pile No.	Condition Rating	Pile Number	Condition Rating
1	1	6	1	11	5
2	3	7	1	12	3
3	2	8	2	13	2
4	1	9	3	14	3
5	3	10	5	15	2
16	3	17	3	18	3

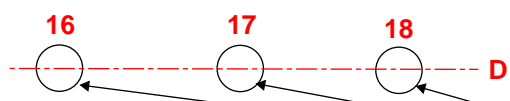

TIMBER MOORING PILES

SINGLE UNSTABLE TIMBER PILE SUPPORTING NORTH END OF SIDE JETTY

PILE SPACING VARIES FROM APPROX. 2.0m TO 2.2m C/C

LOCKABLE ENTRY GATE

MASS CONCRETE

TYPICAL DIAMETER OF SUPPORT PILES 380mm

TIMBER JOISTS NOTCHED AND TWIN BOLTED TO PILES

PRECAST CONCRETE DECK SLABS

DEPTH OF DECK SLABS VARIES BETWEEN 100mm AND 130mm

TYPICAL BEAM SECTION DIMS 190mm X 190mm

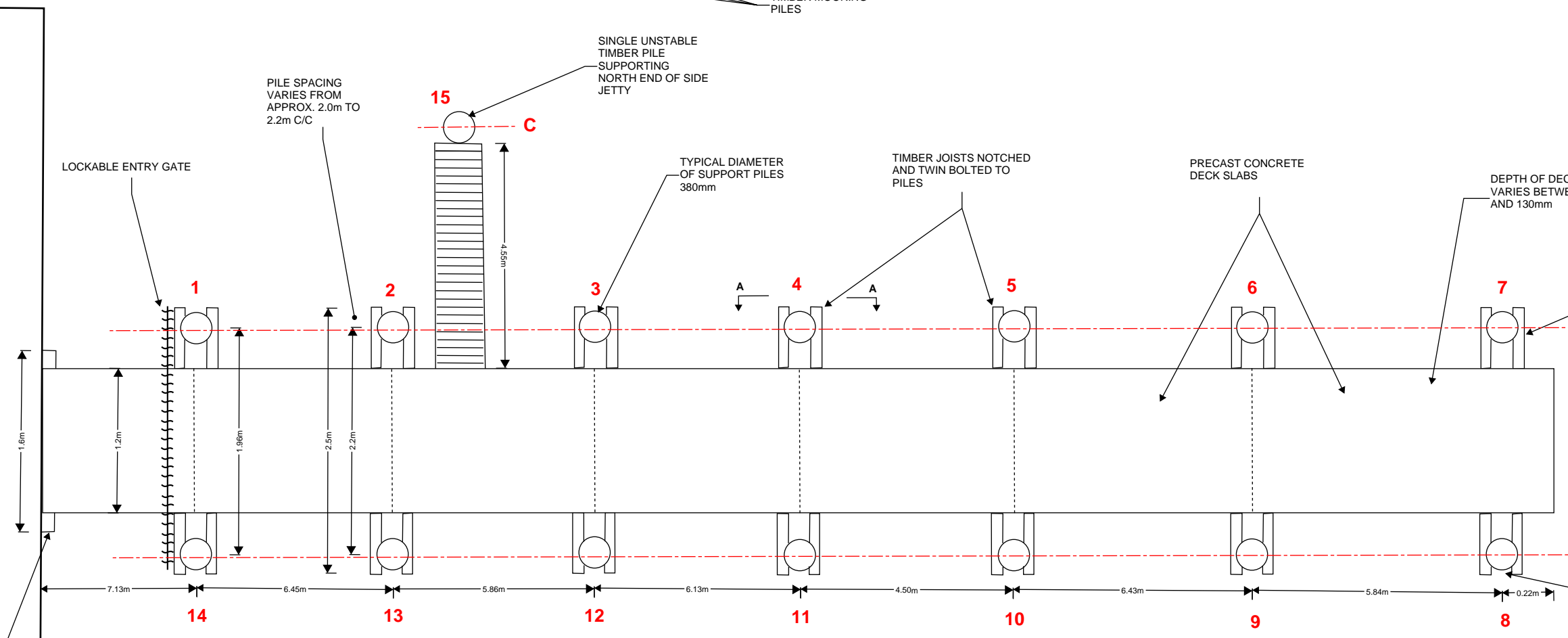

1.6m
1.2m
1.96m
2.5m
2.2m

7.13m 6.45m 5.86m 6.13m 4.50m 6.43m 5.84m 0.22m

BEAM SECTION DIMS 200mm X 300mm

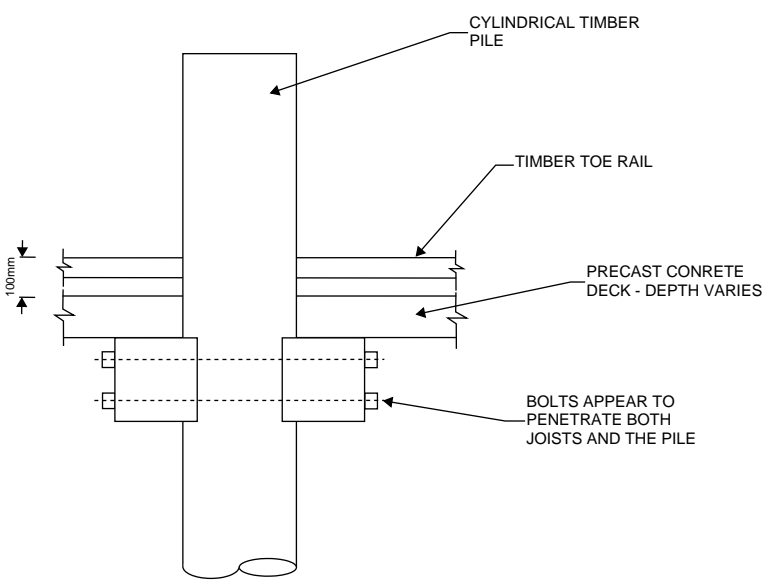
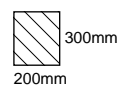

SECTION A-A

PDF ONLY
NO DWG FILE

No.	Revision	By	Chk	Appd	Date
A	FOR INFORMATION	CP			03.18



Original Scale (A1)	Design	Approved For Construction*
Reduced Scale (A3)	Drawn	Date
	Dwg Verifier	
	Dwg Check	

* Refer to Revision 1 for Original Signature

Client: WELLINGTON CITY COUNCIL

Project: WCC WHARF STRUCTURAL INSPECTIONS

Title: EVANS BAY YACHT CLUB NORTHERN FINGER JETTY

Discipline	MARINE STRUCTURAL
Drawing No.	3320740-SE-K102
Rev.	A

6 Evans Bay Yacht Club, South Jetty

6.1 General Description

Evans Bay Yacht Club South Jetty is a timber and concrete construction. It consists of 6no. pairs of timber piles positioned outside the footprint of the deck. 5no. pairs of the piles are orientated such that they are not perpendicular with the edge of the deck. The 6no. sets of bearers are connected to the 6no. pairs of piles by bolted connections. The bearers directly support precast concrete slabs which form the structural deck. The deck slabs are topped with an insitu concrete topping slab. A timber kick board runs along the edges of the deck top.

The jetty deck is 1.24m wide with the piles being approximately 1.7m c/c across the deck. The jetty is approximately 32m long.



Figure 6-1 – Evans Bay Yacht Club South Jetty General Arrangement

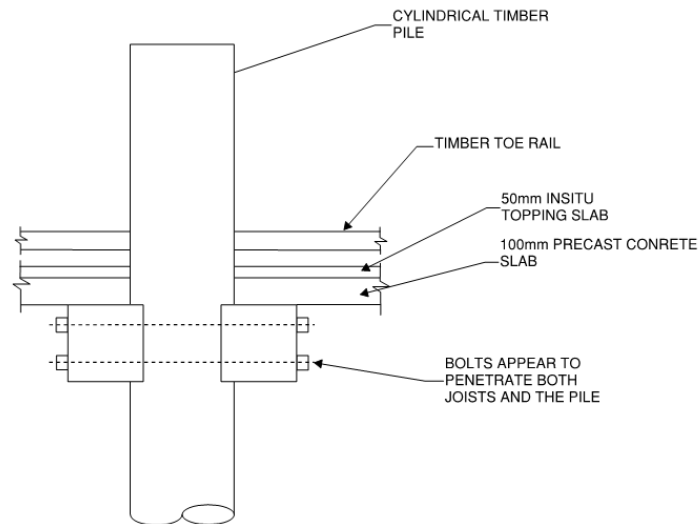

Figure 6-2 - Evans Bay Yacht Club South Jetty Pile Elevation Detail

6.2 Condition Assessment

6.2.1 Piles

The piles were inspected visually both above and below water. Refer to Appendix A for details of the underwater visual inspection and Table 6-2 for a summary of the pile conditions. Above water several piles were found to be in a poor condition either by having lost a significant portion of cross section or having been weakened by rot hollowing out the pile combined with significant splitting. Refer to Figure 6-3 for examples of cross section loss and splitting at the top of the pile. Similar to the north jetty, hollowing out of piles due to rot from the inside as shown in Figure 6-4, was encountered.

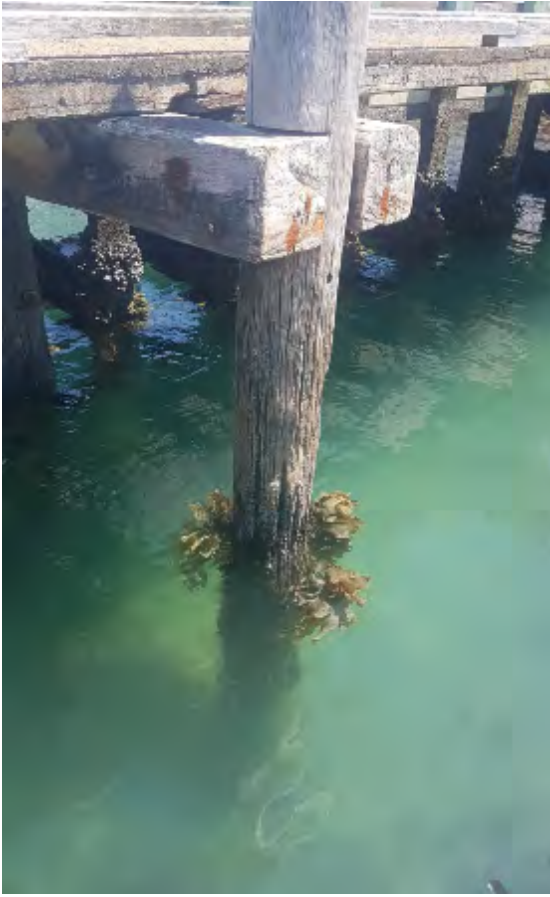

Figure 6-3. Evans Bay Yacht Club South Jetty - Splitting of Piles

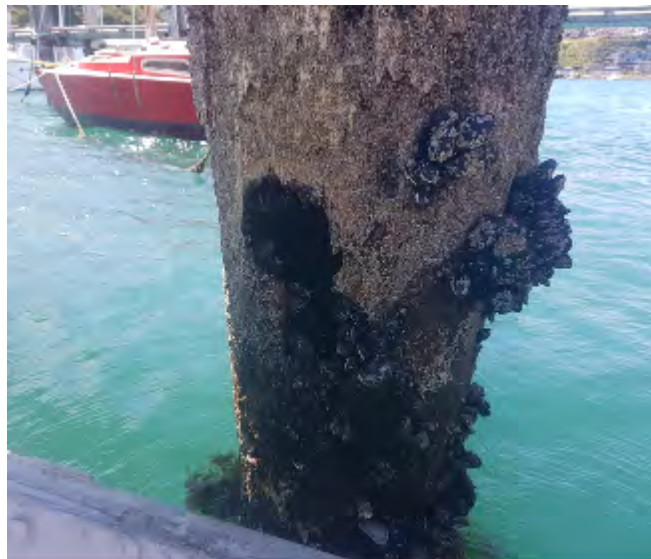

Figure 6-4. Evans Bay Yacht Club South Jetty – Hollowing of Pile Due To Inner Rot

6.2.2 Bearers

The bearers showed varying levels of splitting with more extensive splitting at the ends of the bearers, refer Figure 6-5. However no signs of distress were observed, such as extensive sagging of the bearer.



Figure 6-5. Evans Bay Yacht Club South Jetty - Bearers

6.2.3 Decking

As shown in Figure 6-6 the top of the concrete decking is in a reasonable condition. However the soffit of the decking was found to be subject to spalling of cover concrete, exposure of the bottom reinforcement and reinforcement corrosion also resulting in extensive rust staining of the deck soffit as shown in Figure 6-7.



Figure 6-6. Evans Bay Yacht Club South Jetty - Top of Decking



Figure 6-7. Evans Bay Yacht Club South Jetty - Underside of Decking

With the decking being in a poor condition, replacement of the deteriorating concrete decking should be considered.

6.2.4 Connections and Bolts

Corrosion of the all the bolted connections was advanced and replacement of the bolted connections with stainless connections should be considered.



Figure 6-8. Evans Bay Yacht Club South Jetty - Advanced Corrosion of Bolted Connections

6.3 Above Water Inspection Notes

Table 6-1. Above Water Inspection Notes

Structure	Evans Bay Yacht Club South Jetty		
Date of Inspection	21/11/2017		
Time of Inspection	1:15		
Low Tide Time	1:45		
Grid Reference	Item Description	Condition Description	Condition Rating
A1	Pile	Split through pile	3
B12	Pile	Split through pile	3
A2	Pile	Splitting through surface	3
B11	Pile	Splitting through surface	2
	Bearers - general	Some rot visible	2
	Concrete slabs at bearer locations	Significant localised spalling, rust staining and damage. Re. bar visible. Extensive cracking visible on soffit.	4
A3 and B10	Piles	Some splitting	2
A4	Pile	Splitting in tidal zone	3
B9	Pile	Splitting in tidal zone	3
B8	Pile	Hole in pile in tidal zone	5
A5	Pile	Splitting in tidal zone	3
	Eastern slab span	Significant spalling, rust staining and damage. Re-bar visible	3
A6 and B7	Piles	Minor loss of cross section but significant splitting around circumference of pile	2
	All bolt connections	Significant corrosion	4

6.4 Underwater Inspection Notes

Table 6-2. Underwater Inspection Notes

Pile Number	Condition Rating	Pile Number	Condition Rating	Pile Number	Condition Rating
1	2	5	2	9	2
2	2	6	2	10	2
3	2	7	2	11	2
4	2	8	5	12	3

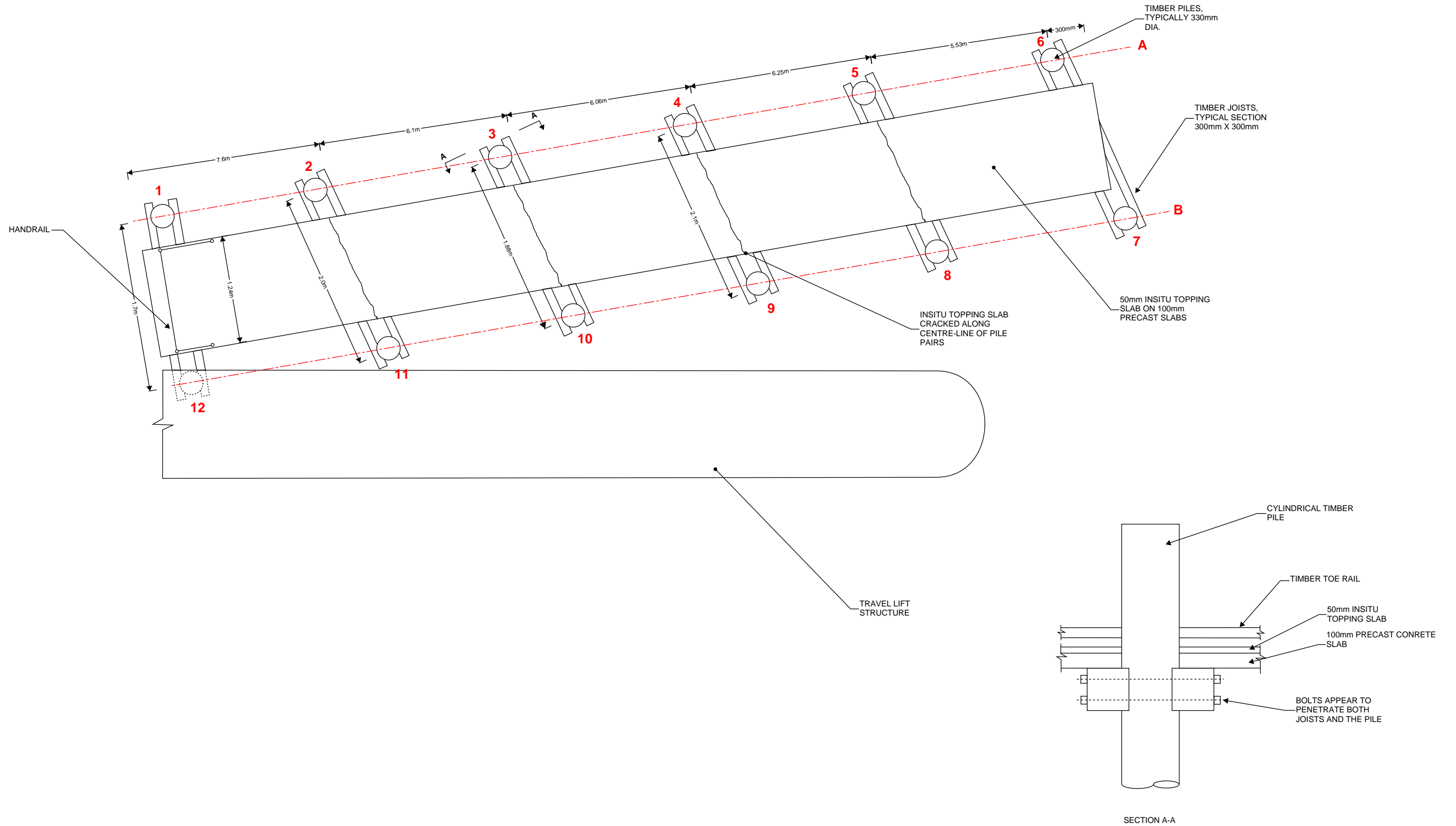

www.beca.com

www.beca.com

PDF ONLY
NO DWG FILE

FOR INFORMATION		CP	11.17
No.	Revision	By	Chk. Appd. Date



Original Scale (A1)	Design	Approved For Construction*
Reduced Scale (A3)	Drawn	Date
	Dwg Verifier	
	Dwg Check	
* Refer to Revision 1 for Original Signature		

Client: WELLINGTON CITY COUNCIL

Project: WCC WHARF STRUCTURAL INSPECTIONS

Title: EVANS BAY YACHT CLUB SOUTHERN FINGER JETTY

Discipline: MARINE STRUCTURAL	Rev: A
Drawing No: 3320740-SE-K103	

DO NOT SCALE

IF IN DOUBT ASK.

BLUEBEAM

7 Evans Bay Yacht Club Travel Lift

7.1 General Description

Evans Bay Yacht Club Travel Lift is a reinforced concrete and steel structure. It consists of 2no. concrete fingers that are supported by steel clad reinforced concrete piles (10no.) and reinforced concrete bearers. There are timber fenders connected around the outside of the structure, secured at their base to timber beams.

The 2no. travel lift fingers are each 25.5m long and 1.5m wide.



Figure 7-1 – Evans Bay Yacht Club Travel Lift

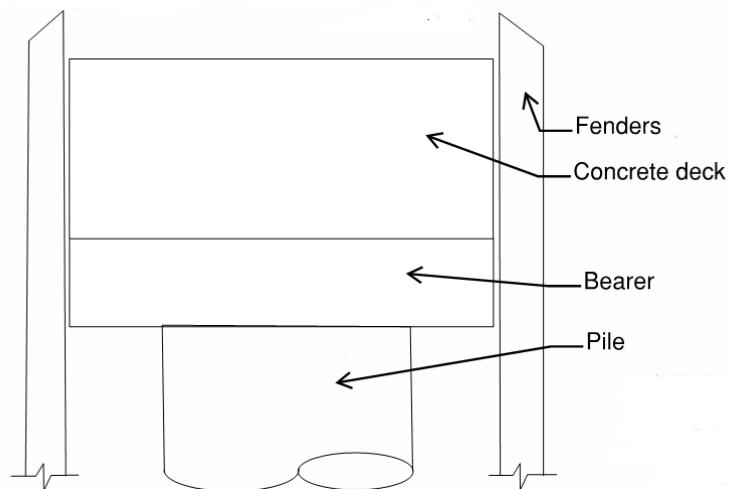

Figure 7-2 – Cross Section of Single Travel Lift Finger Jetty

7.2 Condition Assessment

7.2.1 Piles and Pile Cap

The piles were inspected visually both above and below water. Refer to Appendix A for details of the underwater visual inspection and Section 7.4 for a summary of the pile conditions. Besides expected marine growth and pitting of the steel cladding, the concrete piles were found to be in a good condition above and below water, refer to Figure 7-2.



Figure 7-3. Evans Bay Yacht Club Travel Lift – Steel Clad Concrete Piles In Good Condition

7.2.2 Travel and Access Platforms

The travel lift platforms, that consist of pile caps, were in a reasonable condition, except cracking having been encountered in vicinity of the one of the intermediate pile locations, on the inside face of the northern travel platform. Refer to Figure 7-4.

It is recommended, that these cracks are monitored to confirm if they are signs of distress resulting from ongoing use of the travel lift. It is considered that the cracks may have resulted as part of the damage that was investigated in 2010 and resulted in retro fitting intermediate piles to the structure; the investigation results seem to indicate this.



Figure 7-4. Evans Bay Yacht Club Travel Lift - Vertical Cracking on Inside Face of Northern Platform

Furthermore, localised rust staining due to ongoing corrosion of the north side travel platform toe backing planks was observed. Refer Figure 7-5. It appears at this location, the protective galvanised coating has degraded, exposing the steel planks to sea water. As part of regular maintenance, the two planks in question could be unbolted, rust removed and re-galvanised.



Figure 7-5. Evans Bay Yacht Club travel lift, localised corrosion and rust staining of side mounted steel planks

The protective paint system of the steel beams supporting the traverse access platform appears to have degraded substantially. It is anticipated that the steel beams themselves will soon start to corrode.

It is recommended that the platform is unbolted, steel beams sand blasted to remove any flaking paint and onset of rust, and re-painted.



Figure 7-6. Evans Bay Yacht Club Travel Lift - Traverse Access Platform, Steel Beams, Degradation of Paint System

7.2.3 Bolted Connections

All stainless steel bolted connections fastening the traverse access platform and fenders, appeared to be in a good condition without the need for immediate maintenance actions. Refer to Figure 7-7.



Figure 7-7. Evans Bay Yacht Club Travel Lift - Retrofitted Stainless Steel Connections

7.2.4 Fenders

Besides typical marine growth the fenders appeared to be in a good condition, with the bolted connections in a good condition and no cross section loss encountered. Refer to Figure 7-8 .



Figure 7-8. Evans Bay Yacht Club Travel Lift – Fenders

7.3 Above Water Inspection Notes

Table 7-1. Above Water Inspection Notes

Structure	Evans Bay Yacht Club Travel Lift		
Date of Inspection	21/11/2017		
Time of Inspection	1:50		
Low Tide Time	1:20		
Grid Reference	Item Description	Condition Description	Condition Rating
	All piles	No decay or damage	1
	Fenders	Minor rot in tidal zone	1 to 2
	Concrete deck general, south face of B	No obvious cracking	1
B7	Concrete deck South side	Minor surface crack	2
B7	Pile bearers concrete	Good condition	1
B7	Concrete North side of B	No visible cracking	1
A2-B7	Steel and timber walkway	Support brackets surface corrosions - peeling paint	2 to 3
A2-B7	Street and timber walkway	Steel beams - paint flaky and initial signs of localised corrosion	2
A	Piles on grind A	All good condition. Minor marine growth in tidal zone	1
	Concrete deck north face	Very minor cracking - more significant at A1 and B10	1

7.4 Underwater Inspection Notes

All piles found to be condition rating 6 – the steel cladding of the reinforced concrete piles was found to be pitted with rust staining around the pitting. The reinforced concrete piles are considered condition rating 1.

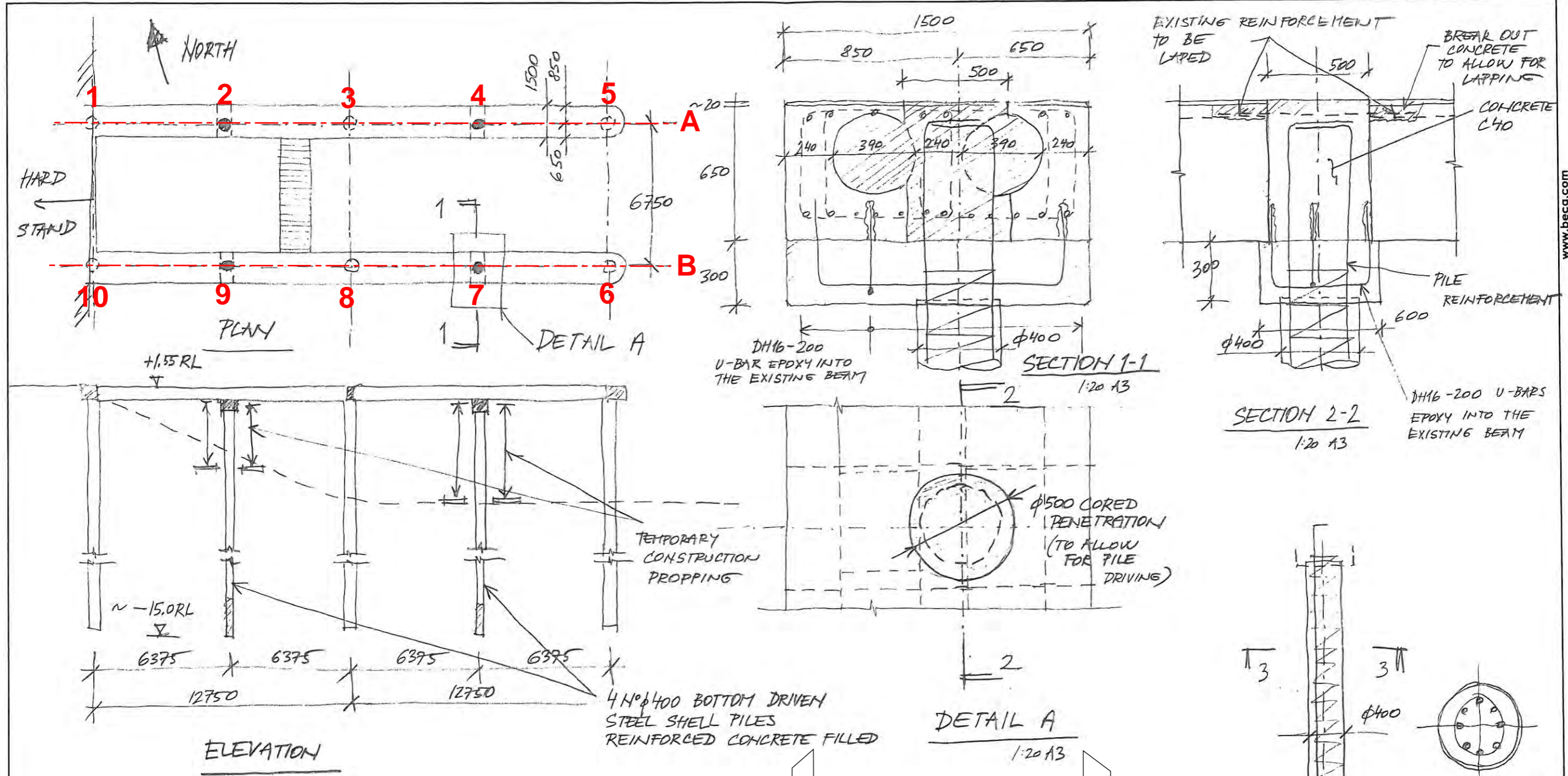

- NOTES:
1. THE CAPACITY OF PILES TO BE CHECKED USING HILEY DRIVING FORMULA. MIN ULTIMATE GEOTECHNICAL CAPACITY SHOULD BE 3000KN
 2. CONCRETE TO BE GRADE C40. STEEL CASING TO BE GRADE 250.
 3. EXPOSED PARTS OF THE EXISTING BEAMS TO BE PROVIDED WITH PROJECTIVE PAINT SYSTEM - SIKA PRIMER S AND SIKA GUARD -550 ELASTIC

Drawing Originator: 		Original Scale (A3): NTS	Design: Drawn: Dsg Verifier: Dwg Check:	Approved For Construction* Date:	Client: WCC	Project: TRAVELIFT BEAMS	Title: STRENGTHENING BY PILES	Discipline: STRUCT
# FOR INFORMATION Revision:		By: [Signature] Chk: [Signature] Appd: [Signature] Date: 28/09/10	* Refer to Revision 1 for Original Signature		Date:	Drawing No.: SK2	Rev: A	Drawing No.: SK2

8 Evans Bay Boat Ramp, North Jetty

8.1 General Description

The Evans Bay Boat Ramp North Jetty is a timber and concrete structure. The structure comprises 5no. pairs of timber piles connected to timber bearers which support a precast concrete deck with a timber kick board around its top edge.

The jetty deck is 2m wide and 17.8m long.



Figure 8-1 – Evans Bay Boat Ramp North Jetty General Arrangement

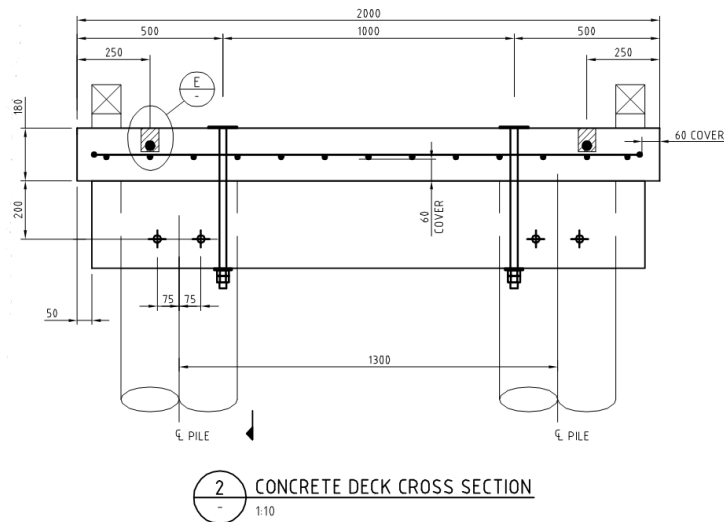

Figure 8-2 – Evans Bay Boat Ramp North Jetty Cross Section Detail

8.2 Condition Assessment

8.2.1 Piles

As shown in Figure 8-3 the piles were found in a good condition, besides typical marine growth. As part of regular maintenance, removal of marine growth could be considered.



Figure 8-3. Evans Bay Boat Ramp North Jetty Piles

8.2.2 Bearers and Bolted Connections

Both the bearers and stainless steel bolted connections, as shown in Figure 8-4 were found in a very good condition with no maintenance actions required.



Figure 8-4. Evans Bay Boat Ramp North Jetty, Bearers and Connections

8.2.3 Decking

As shown in Figure 8-5, the concrete decking is in a very good condition. The same applies to the timber ramp leading from the main boat ramp to the concrete decking.



Figure 8-5. Evans Bay Boat Ramp North Jetty - Timber Decking

8.2.4 Fenders

With the fenders being exposed to the tidal zone, the observed marine growth shown in Figure 8-6 was expected. It is recommended that the marine growth is removed as part of routine maintenance as it may be masking unseen decay or damage.

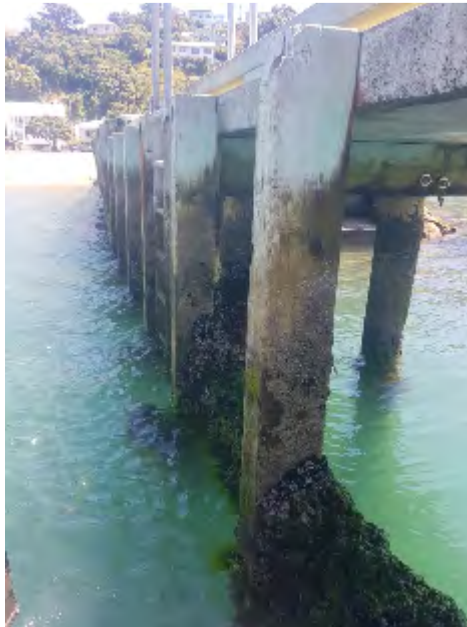

Figure 8-6. Evans Bay Boat Ramp North Jetty, Marine Growth on Fenders

8.3 Above Water Inspection Notes

Table 8-1. Above Water Inspection Notes

Structure	Evans Bay Boat Ramp North Jetty		
Date of Inspection	21/11/2017		
Time of Inspection	13:15		
Low Tide Time	13:20		
Grid Reference	Item Description	Condition Description	Condition Rating
B10, All	Pile(s)	Very minor rot in tidal zone. Some marine growth - same for all piles.	1
	Concrete deck - general	No visible cracking. Slab joints grout is sound.	1
	Fenders general	Some minor damage due to mooring vessels. Minor rot in tidal zone.	1 to 2
	Piles general	Very minor rot in tidal zone	1
B7 - A4	Bearer	Splitting at bolt locations	2
B2	Bearer	Splitting at bolt locations	2
	Bolt connections - stainless steel	Good condition	1

8.4 Underwater Inspection Notes

Table 8-2. Above Water Inspection Notes

Pile Number	Condition Rating	Pile Number	Condition Rating
1	1	6	1
2	1	7	1
3	1	8	1
4	1	9	1
5	1	10	1

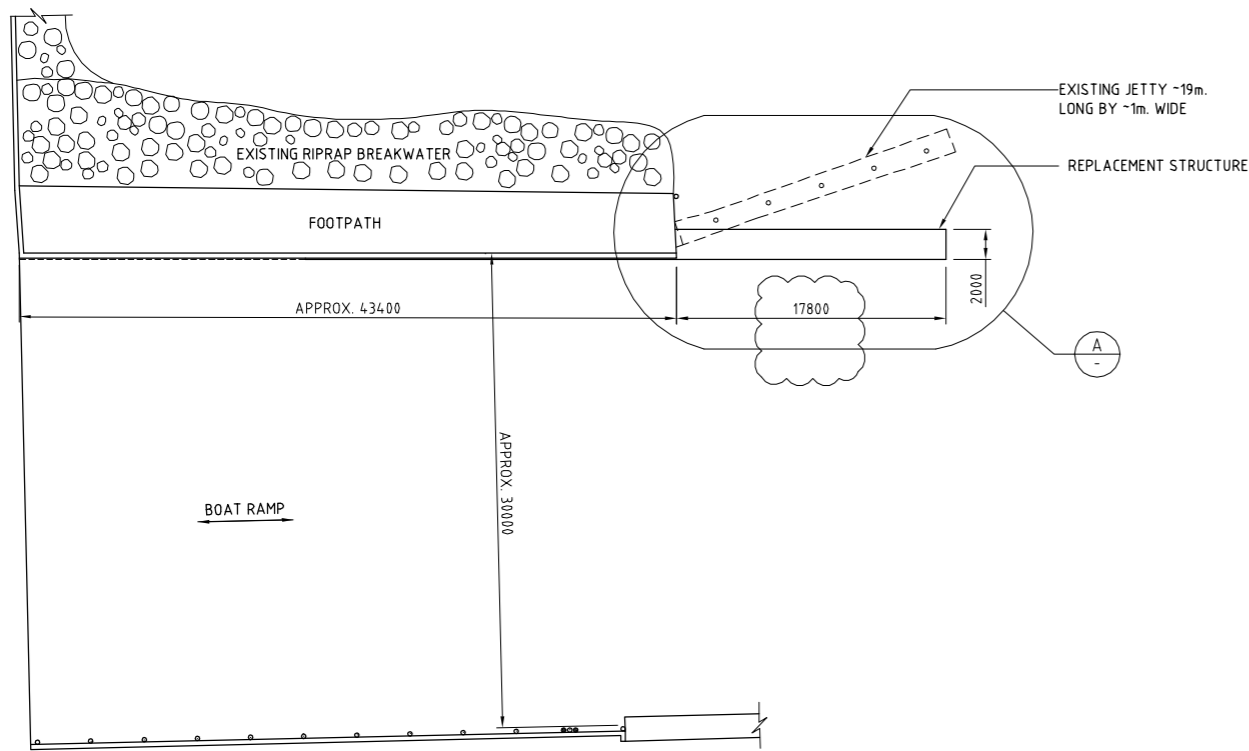

PLAN - EVANS BAY YACHT CLUB BOAT RAMP

1:500

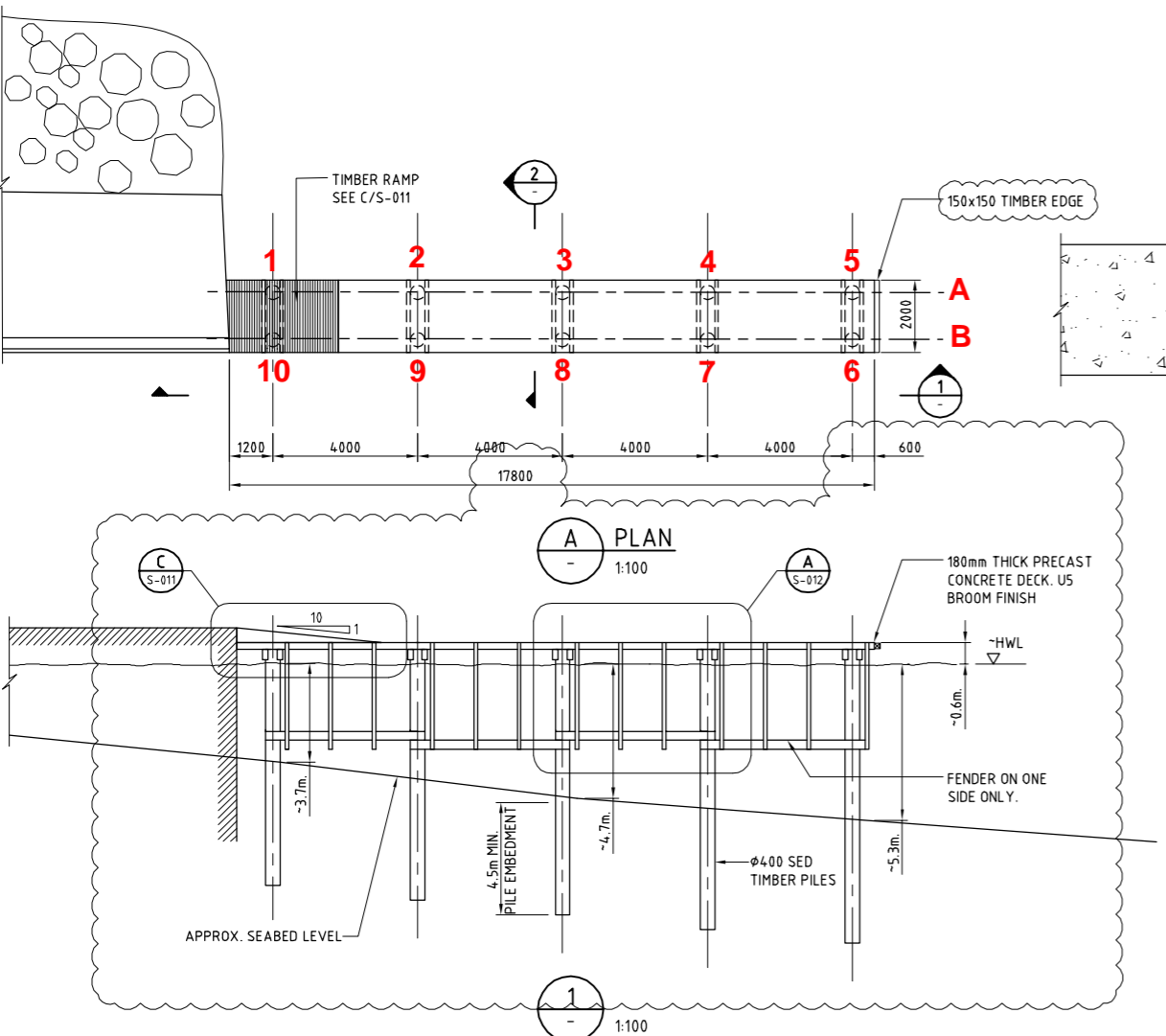

PLAN

1:100

B DETAIL

1:5

TYPICAL BOTH SIDES OF JETTY

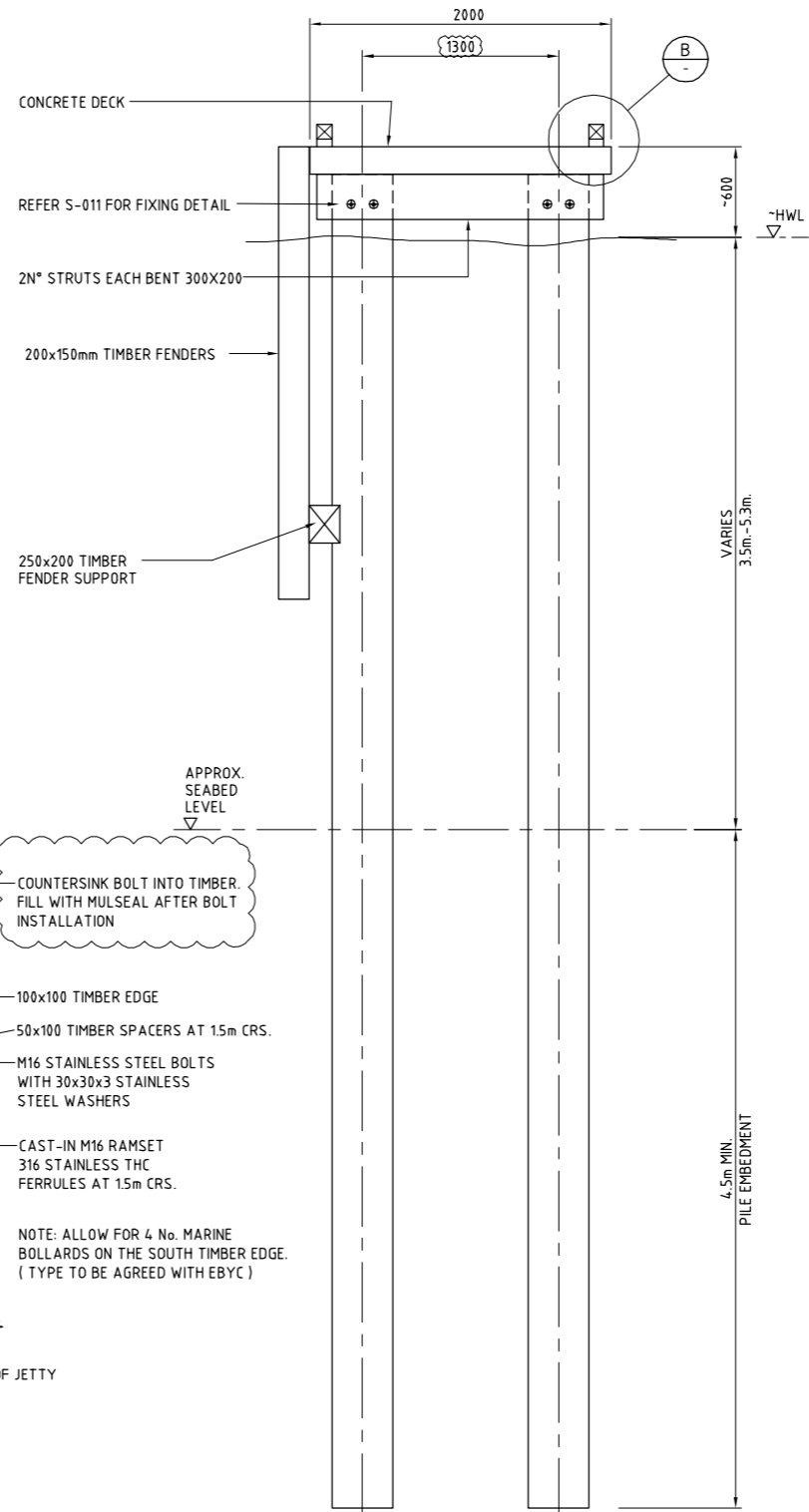

2 SECTION

1:25

GENERAL NOTES:

1. ALL DRAWINGS SHALL BE READ IN CONJUNCTION WITH THE SPECIFICATION, ANY DISCREPANCIES SHALL BE REFERRED TO THE ENGINEER FOR RESOLUTION.
2. SUBSTITUTION FOR OR AMENDMENT OF SPECIFIED DETAILS OR MATERIALS SHALL NOT BE CARRIED OUT WITHOUT APPROVAL FROM THE ENGINEER.
3. STANDARDS LISTED REFER TO THEIR LATEST ISSUE INCLUDING AMENDMENTS THAT ARE CURRENT AT THE TIME OF TENDER.

DIMENSIONS:

1. DISCREPANCIES SHALL BE REFERRED TO THE ENGINEER FOR RESOLUTION.
2. DO NOT SCALE THE DRAWINGS.
3. ALL DIMENSIONS TO EXISTING WORK ARE APPROXIMATE ONLY AND SHALL BE VERIFIED BY SITE MEASUREMENT PRIOR TO FABRICATION AND CONSTRUCTION.

CONCRETE:

1. CONCRETE TO BE 40MPa PRECAST WITH 30% FLYASH WITH MINIMUM CONCRETE COVER OF 60mm ASSUMING AN EXPOSURE CLASSIFICATION "C".
2. 20x20mm CHAMFERS TO USED ON CORNERS.
3. ALL REINFORCEMENT SHALL BE GRADE 500 AS PER AS/NZS 4671

TIMBER:

1. UNLESS SPECIALLY INDICATED OTHERWISE ALL TIMBER CONSTRUCTION SHALL COMPLY WITH NZS 3603, NZS 3604 AND AS/NZS 4357.
2. TIMBER BEARERS TO BE No. 1 FRAMING RADIATA PINE OR GREATER AND TREATED TO TPC GRADE H6.
3. PILES TO BE HARDWOOD PILES STRENGTH GRADE S5 OR HIGHER IN ACCORDANCE WITH AS/NZS 2878:2000 AND PROVIDED WITH CCA TREATMENT TO GRADE H6 AS PER AS1604:2000 TO ACHIEVE DURABILITY OF 40+ YEARS IN MARINE ENVIRONMENT. THE CONTRACTOR SHALL SUBMIT THE SELECTED PILE TYPE FOR ENGINEER APPROVAL SHOWING THAT IT MEETS THE SPECIFIED REQUIREMENTS.
4. PILES TO BE DRIVEN TO ACHIEVE A SAFE WORKING LOAD OF 90kN USING HILEY FORMULA. MINIMUM EMBEDMENT SHALL BE 4.5m (METRES) DEEP INTO SEABED. PILES TO BE REDRIVEN AFTER AT LEAST 24 HOURS TO CONFIRM SET.

FIXINGS:

1. ALL FITTINGS INCLUDING BOLTS, THREADED RODS, NUTS, WASHERS ETC. SHALL BE STAINLESS STEEL GRADE 316 AS PER THE SAE DESIGNATION.

TYPICAL BOLTING DETAIL:

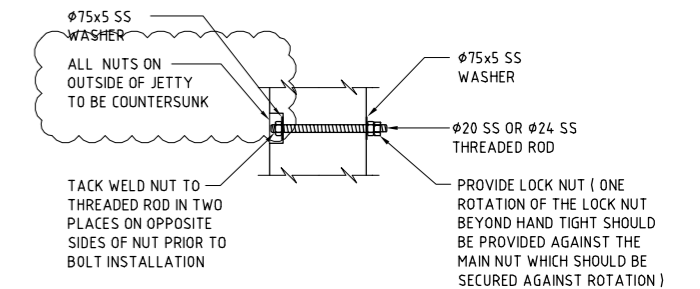

DESIGN BASIS:

1. DESIGN CODES:
 - NZS 3101:2006 - CONCRETE STRUCTURES
 - NZS 3603:1993 - TIMBER STRUCTURES
 - AS 4997:2005 - GUIDELINES FOR THE DESIGN OF MARINAS
2. DESIGN LIFE 50 YEARS
3. IMPORTANCE LEVEL 1

FOR CONSTRUCTION

1	FOR CONSTRUCTION	RAL	HWT	RDJ	22.12.10
0B	FOR BUILDING CONSENT	RAL	VH	RDJ	01.10.10
0A	RE-ISSUED FOR TENDER	RAL	VH	RDJ	24.09.10
0	FOR TENDER	WN	VH	RDJ	14.09.10
No.	Revision	By	Chk	Appd	Date

Drawing Originator: **Beca**

Original Scale (A1) SHOWN	Design Drawn	CA	22.12.10	Approved For Construction*
Reduced Scale (A3) SHOWN	Dwg Verifier	SK	22.12.10	BJS
	Dwg Check	VH	22.12.10	Date

* Refer to Revision 1 for Original Signature

Client: **Absolutely Positively**

Project: **EVANS BAY SEAWALL REMEDIAL WORKS**

Title: **FINGER JETTY REPLACEMENT GENERAL ARRANGEMENT**

Discipline: **STRUCTURAL**

Drawing No. **3320740-S-010**

Rev. **1**

9 Evans Bay Boat Ramp, South Jetty

9.1 General Description

Evans Bay Boat Ramp South Jetty is a timber structure. The timber piles support overlapped timber joists which connect either side of the piles. The timber deck is formed around the piles so that the pile tops sit between approximately 400mm and 1m above the deck surface.

The jetty deck is approximately 1m wide and the jetty approximately 22m long.



Figure 9-1 – Evans Bay Boat Ramp South Jetty General Arrangement

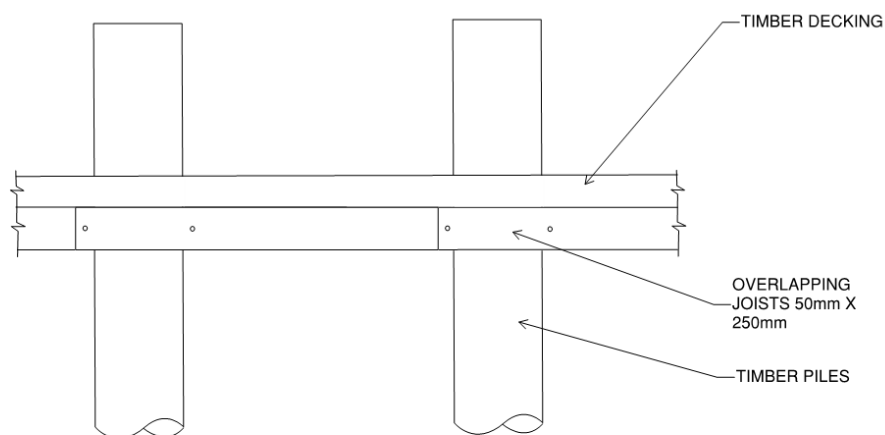

Figure 9-2. Evans Bay Boat Ramp South Jetty Elevation Detail

9.2 Condition Assessment

9.2.1 Piles

The piles were inspected visually both above and below water. Refer to Appendix A for details of the underwater visual inspection and Table 9-2 for a summary of the pile conditions. Above water most piles were found in a deteriorated condition with all the piles being subject to cross section loss and extensive splitting at the top of the piles, as shown in Figure 9-3. However, the below water condition of the piles was found to be good with only A7 showing signs of instability due to its assumed shallow embedment.



Figure 9-3. Evans Bay Boat Ramp South Jetty - Loss of Cross Section and Splitting of Timber Piles

9.2.2 Joists and Connections

The overlapping joists were found in a reasonable condition, as can be seen in Figure 9-4, with the exception of the last joist, shown in Figure 9-5, where the end of the joist split and the timber below has broken off.



Figure 9-4. Evans Bay Boat Ramp South Jetty – Overlapping of Decking Joists



Figure 9-5. Evans Bay Boat Ramp South Jetty – Joist Split With Broken Off Timber Section

It would be recommended that the last seaward joist is replaced.

9.2.3 Decking

The decking was found to be in a reasonable condition, with the exception of decking edging missing between A2 and A4 piles on the northern side of the decking. Refer to Figure 9-7. It would be recommended to replace the edging.



Figure 9-6. Evans Bay Boat Ramp South Jetty, decking



Figure 9-7. Evans Bay Boat Ramp South Jetty – Missing Deck Edging Plank

9.3 Above Water Inspection Notes

Table 9-1. Above Water Inspection Notes

Structure	Evans Bay Boat Ramp South Jetty		
Date of Inspection	21/11/2017		
Time of Inspection	13:30		
Low Tide Time	13:20		
Grid Reference	Item Description	Condition Description	Condition Rating
A1	Pile	Rot in tidal zone. Minor marine growth.	2
A2	Pile	Hollowing at top.	2
A2	Bolt connections	Significant Corrosion.	3
A3	Pile	Pok marks in tidal zone. Some loss of cross section. Splitting above tidal zone.	3
	Kick boards general	All kick boards missing or loose.	6
	Connections general	Significant corrosion.	3
A4	Pile	Significant splitting above and in tidal zone	3
A5	Pile	Splitting at top of pile	3
A6	Pile	Significant splitting above and in tidal zone. Some rotting.	2 to 3
A7	Pile	Pile 'flexible' due to diameter and height above sea bed level ~6-7m. Physical condition good.	1
A7	Joist	Single bolt through Pile, not double as with others. End section of southern joist broken off.	6
	Joists general	Some marine rot and splitting	2

9.4 Underwater Inspection Notes

Table 9-2. Underwater Inspection Notes

Pile Number	Condition Rating	Pile Number	Condition Rating
1	1	5	3
2	3	6	2
3	1	7	1
4	3		

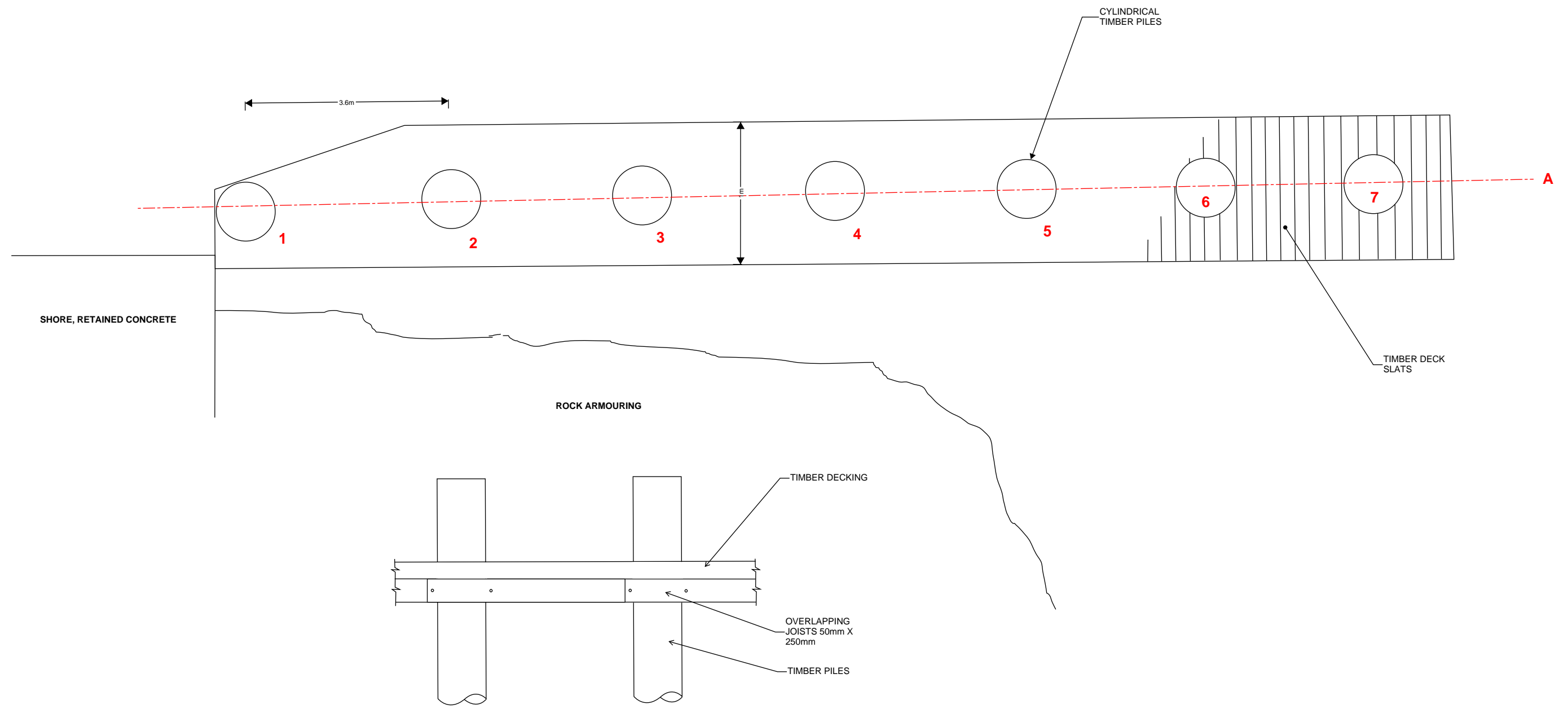

PDF ONLY
NO DWG FILE

No.	Revision	By	Chk	Appd	Date
A	FOR INFORMATION	CP			11.17



Drawing Originator:	Original Scale (A1)	Design	Drawn	Approved For Construction*
	Reduced Scale (A3)	Design Verifier	Dwg Check	Date

* Refer to Revision 1 for Original Signature

Client: WELLINGTON CITY COUNCIL

Project: WCC WHARF STRUCTURAL INSPECTIONS

Title: EVANS BAY YACHT CLUB SOUTHERN FINGER JETTY

Discipline	MARINE STRUCTURAL
Drawing No.	3320740-SE-K104
Rev.	A

10 Seatoun Wharf

10.1 General Description

Seatoun Wharf is a timber and concrete structure. The structure comprises a long narrow pier that widens at its end into a large square (in plan) structure. The end structure is orientated at an angle to the narrower pier. The timber piles connect to bearers at their top which support 5no. joists and timber deck rails topped with a thin insitu chip-seal topping layer. There are timber hand rails present, 1.3m high, and a kick board the length of the narrower pier perimeter. The large square structure has a similar make up but does not have a handrail around the perimeter.

The full length of the wharf is approximately 80m. The narrower pier is 2.66m wide and the square section 7.1m wide.



Figure 10-1 – Seatoun Wharf General Arrangement

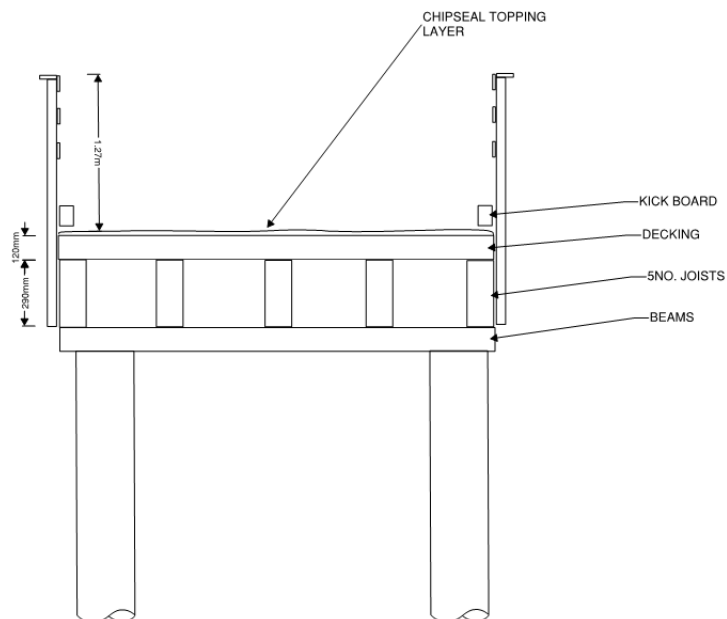

Figure 10-2 – Seatoun Wharf Cross Section Detail

10.2 Condition Assessment

10.2.1 Piles

The piles were inspected visually both above and below water. Refer to Appendix A for details of the underwater visual inspection and Table 10-2 for a summary of the pile conditions.

The piles that were concrete encased appeared to be in a better condition than the timber piles completely exposed to seawater, in particular within the tidal zone. The exposed piles were found to have significant rot damage, cross section loss and splitting of the exterior.



Figure 10-3. Seatoun Wharf - Splitting and Cross Section Loss of Non-Encased Timber Piles

Furthermore it was observed that previous pile repairs comprising sistering of timber joists to existing timber piles stopped short of being embedded into the marine bed. These instead bore on concrete encased pile sockets above marine bed level. Therefore, these pile repairs were not considered to be providing continuity across the weakened pile section. Hinging of these sistered piles in conjunction with severely deteriorated timber bracing, as described in section 10.2.1 of this report, may have led to a lateral shunting of the ferry landing platform piles shown in Figure 10-5.

In light of the shunting and inclination of the timber piles observed, it appears the lateral stability of the landing platform to cater for ferry landing impact against the fenders is compromised and repairs or installation of the replacement piles with adequate socketing into the marine bed and new timber bracing supporting and restraining the landing platform should be considered urgently as the wharf is in regular passenger use.



Figure 10-4. Seatoun Wharf – Left, Concrete Encased Timber Piles, Right, Previous Repair of Timber Piles By Sistering



Figure 10-5. Seatoun Wharf - Left, Sistering of Existing Timber Piles Not Fully Extending to Marine Bed. Right, Lateral Shunting of Sistered Piles

10.2.2 Joists and Bearers

Common defects to most joists and bearers comprised splitting of the beam ends as shown in Figure 10-6.



Figure 10-6. Seatoun Wharf – Splitting of Bearer and Joist Ends

However, more onerous white rot was encountered on one the bearers supporting the landing platform. No other signs of distress to this bearer were observed. However, it is recommended that the white rot is treated to stop it spreading and a timber sample is taken to check the penetration of the rot.



Figure 10-7. Seatoun Wharf - White Rot on Bearer, D2-E2

Most of the bearers supporting the landing platform had been wrapped with copper sheeting to provide additional protection from seawater. Along the internal bearers the copper sheeting has torn locally (refer Figure 10-8), whereas along the external bearers most of the copper sheeting was either torn or missing (refer Figure 10-9). In the latter case white rot of an external bearer was also observed.

It is strongly recommended that the white rot is treated as soon as possible to limit any further deterioration. Drill samples should also be taken to check how far the white rot has penetrated the bearer. Depending on the penetration depth, this bearer will be need to strengthened or replaced.



Figure 10-8. Seatoun Wharf – Copper Cladding on Joist



Figure 10-9. Seatoun Wharf – Torn and Missing Copper Cladding, and White Rot on External Bearer, C3-C4

10.2.3 Decking

The decking planks were found in a reasonable condition with splitting at the beam ends. Refer to Figure 10-10.



Figure 10-10. Seatoun Wharf – End Splitting of Decking Planks

The decking surfacing along the access jetty leading to the ferry platform, shown in Figure 10-11 was found to have cracked between individual decking joists, but still provided skid resistance for pedestrian traffic. It is recommended to renew the surfacing to also provide better environmental protection to the decking joists.

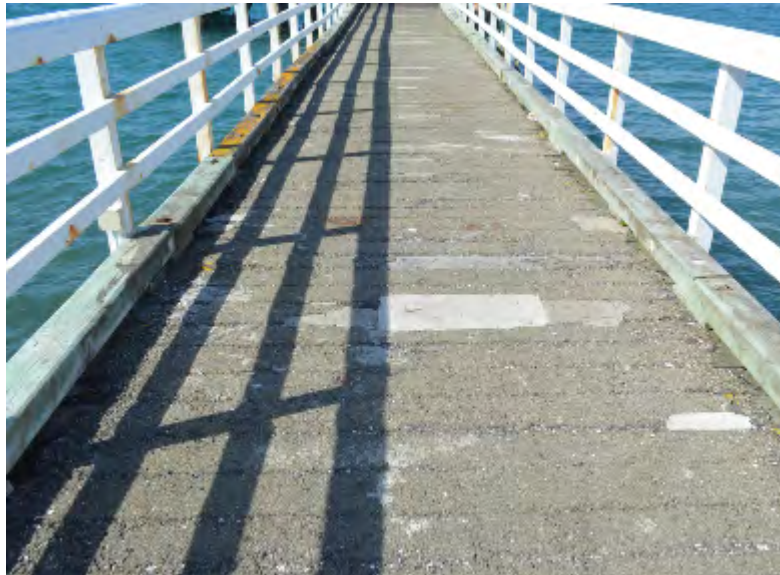

Figure 10-11. Seatoun Wharf – Cracking in Deck Surfacing

The surfacing of the landing platform was found in a much better condition. Refer to Figure 10-12.



Figure 10-12. Seatoun Wharf – Mooring Platform Decking

10.2.4 Connections and Bolts

All the bolted connections showed advanced deterioration due to corrosion with examples shown in Figure 10-13. It is recommended to replace all bolted connections as part of wharf maintenance.



Figure 10-13. Seatoun Wharf, Observed poor condition of bolted connections

10.2.5 Bracing

Besides marine growth, the bracing of the access jetty was found to be in a reasonable condition with little loss of cross section in bracing members encountered. Refer to Figure 10-14 for a typical access jetty pile bracing. However, the bracing for the landing platform appeared to provide very limited restraint to the landing piles, resulting in shunting of the piles as shown in Figure 10-15.

It is recommended to replace the existing pile bracing to assist in restoring lateral restraint of the landing piles and described in section.



Figure 10-14. Seatoun Wharf – Bracing of Access Jetty

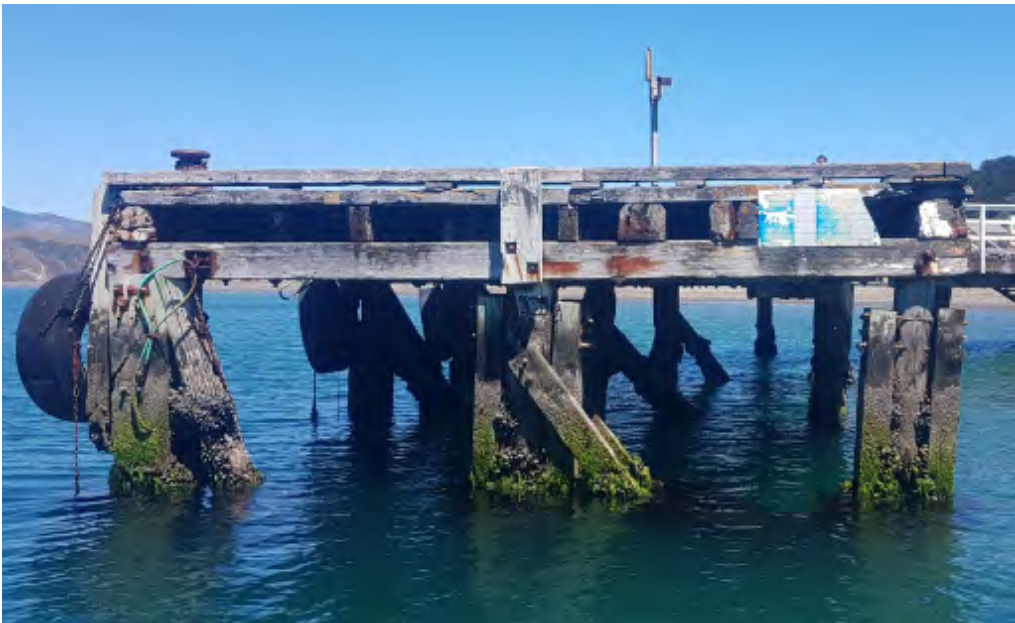

Figure 10-15. Seatoun Wharf – Mooring Platform End Elevation

10.2.6 Fenders

It appears, as indicated in Figure 10-16, that the three original timber fenders have been substituted with large tyres. The central fender appeared to have lost some of its bolted restraint and was found tilting. It is recommended to re-fasten the fender.



Figure 10-16. Seatoun Wharf - Fenders

10.2.7 Access Stairs

The access stairs shown in Figure 10-17 were subject to marine growth within the submerged and tidal zone, but did not show any other defects affecting its condition.



Figure 10-17. Seatoun Wharf - Stairs

10.3 Above Water Inspection Notes

Table 10-1. Above Water Inspection Notes

Structure	Seatoun Wharf		
Date of Inspection	23/11/2017		
Time of Inspection	1:15		
Low Tide Time			
Grid Reference	Item Description	Condition Description	Condition Rating
	Joists (those over land) western side, first 2 spans from shore	Significant surface splitting	3
	Bolts (those over land)	Significant corrosion present	4
	Decking	Significant splitting at ends. Some rot on under side	3
	Beams (those over land)	Splitting at ends and in main body	3
	Joists (those over land), eastern side, first two spans from shore	Some splitting at ends	2
A1, B1, A2, B2	Piles	Loss of cross section and some splitting	3
A3-B3	Joists	End splitting	3
A3-A4	Joists	Some splitting	2
A4-B4 and A3-B3	Pile headers and joists	End splitting	3
A4/B4, A3, B3	Pile - concrete encasement	Some minor scour around construction joint	2
A5 and B5	Piles	Same as A4 and B4 - slightly better - less loss of concrete	1 - 2
B6	Pile	Timber pile splitting, concrete wrap ok - some marine growth, no cladding to upper	3
B6	Joists	Some decay and splitting	2
B6	Bolt connections	Some minor corrosion	2
A6	Pile	Full length concrete wrap to timber pile - marine growth present. Some evidence of timber pile splitting at top	2
A7 and B7	Piles	Concrete wrap some loss of cross section	2
A7 - B7	Joists	Some decay and splitting	2
A8 - B8	Diagonal cross bracing between piles	Some decay and splitting	2
A8	Pile	Timber at top loss of cross section - copper wrap	2
B8	Pile - Timber and wrap	Good condition	1

A8 new	Pile - new	Some marine growth present, good condition	1
B9	Pile	Hole in tidal zone - susceptible to scour and internal rot	4
A9	pile	Top splitting 2x metal rings at top holding piles together	3
A9 - B9	Joists	Some surface rot and end splitting.	2
A9 - B9	Bolts	Significant corrosion present	3
A9 - B9	Stair	Marine growth in tidal zone. Some surface rot of timber members.	2
A10	Pile	Splitting - metal rings holding together,	3
B10	Pile	Some loss of cross section	3
A11	Pile	Loss of cross section and splitting (surface)	3
B11	Pile	Loss of cross section and splitting (surface)	3
	Connections - general	All connection have significant corrosion visible. Unable to tell if corrosion penetrated full cross section of bolts etc.	3
	Joists - general	Although some joists are a lower rating the majority of them throughout the structure suffer from significant surface white rot and end splitting.	6
E1	Piles strengthened with vertical timber splints	Timber with wrapping	3
D1	Piles strengthened with vertical timber splints	Original Members	3
D1	Piles strengthened with vertical timber splints	New Members	1
E1 - D1	Cross Bracing	Marine growth in tidal zone.	1
C2 and D2	Piles	Significant loss of cross section.	3
C2/D3	Cross Bracing	Marine growth in tidal zone.	1
E2	Pile original	Significant loss of cross section.	3
E2	Pile new splint	Some loss of cross section and marine growth in cross section.	2
C2, D2, E2	Bearer Beam	Surface rot and mould.	6
	Bolt connections general	Significant corrosion present on all connections.	3
	Joists general	Some copper clad for added protection - the copper cladding appears to have slowed the rate of degradation. Most of the cladding is now in a state of disrepair though.	2/3

C2 - C3, C3 - C4	Joists	Surface white rot due to a loss of copper cladding	6
C3	Pile	Loss of cross section	3
D3	Pile	Loss of cross section	3
E4	Pile, Original & with splint	Original - hole in tidal zone - susceptible to scour and internal rot. Splice -only extends over a short length of the pile, therefore provides some support but does not fully strengthen the pile. Chain damage to splice.	org. 5 with splint 4
E4	Joist connection	Significant decay and splitting at connection	3
E3,D3	Cross Bracing	Marine growth in tidal zone	1
Grid 2 and 3	Bearers	Some end splitting and surface rot.	2 to 3
C4	Pile	Large hole in original	5
E4, D4	Piles	Splicing not deep enough below water.	4
E4-D4	Cross Bracing, raking pile	No cross bracing present. Appears to be a raking pile present between E4 and D4. Below water connection unknown?	6
D4 and C4	Pile alignment	Piles inclined - assumed due to ferry mooring forces	6
E4	Raking pile	Splitting and loss of cross section	4
E4	Vertical pile	Original and Splice	4
Grid 4	Joists	Splitting at end - significant	3 to 4
D4 - C4	Cross Bracing	Marine growth	1

10.4 Underwater Inspection Notes

Table 10-2. Underwater Inspection Notes

Pile Number	Condition Rating	Pile Number	Condition Rating	Pile Number	Condition Rating
A1	N/A	B1	N/A	C1	2
A2	N/A	B2	N/A	C2	2
A3	N/A	B3	2	C3	2
A4	1	B4	2	C4	5
A5	2	B5	3	D1	2
A6	1	B6	1	D2	2
A7	2	B7	2	D3	2
A8	5	B8	1	D4	2
A8a	1	B9	4	E1	2
A9	1	B10	2	E2	2
A10	2	B11	2	E3	5
				E4	3

FOOTPATH
ADJACENT ROAD

TIDE LINE AT TIME
OF SITE WALKOVER

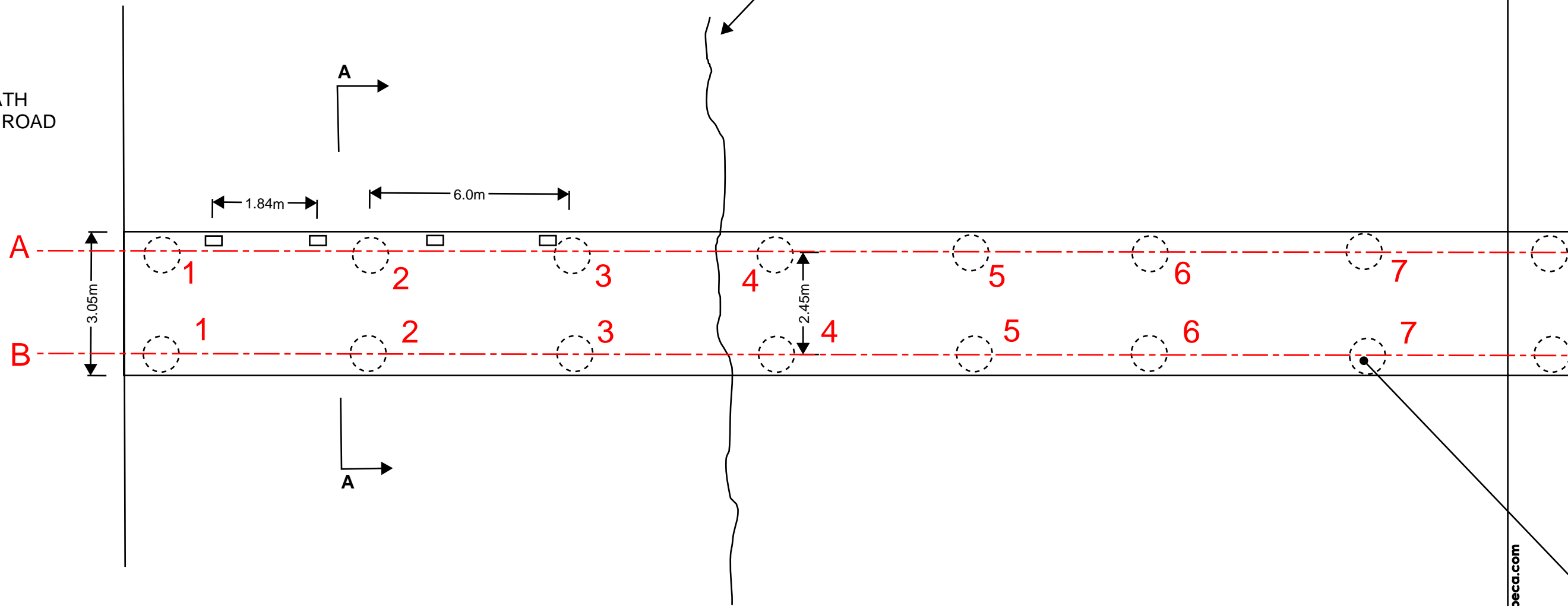

No.	Revision	By	Chk	Appd	Date

Drawing Originator:
Beca

Original Scale (A1)	Design	Approved For Construction*
Reduced Scale (A3)	Drawn	Date
	Dwg Verifier	
	Dwg Check	
* Refer to Revision 1 for Original Signature		

Client:	Project:

Title:	Discipline:

Drawing No.	Rev.

11 Karaka Bay Wharf

11.1 General Description

Karaka Bay Wharf is a timber and concrete structure. The timber deck joists supported by timber bearers connected to 4no. pairs of timber support piles as well as a mass concrete pier with 3no. short columns on top. The landward end of the wharf deck structure is supported by and fixed to a mass concrete abutment. The joists support timber decking which are topped with a thin layer of chipseal. Timber kick boards run around the circumference of the deck top along with a timber handrail. The end seaward pair of piles has cross bracing to provide some extra lateral stability.

The length of the wharf is approximately 31m and the width of the deck is approximately 2.6m.



Figure 11-1. Karaka Bay Wharf General Arrangement

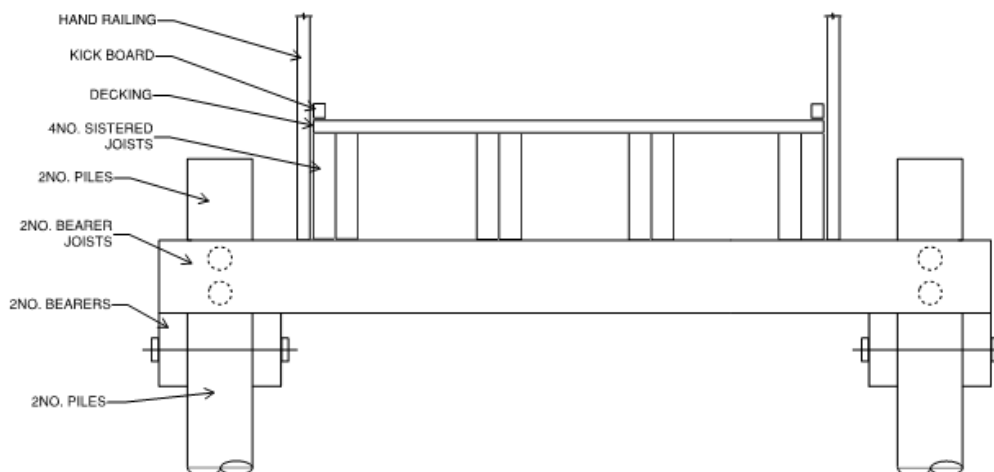

Figure 11-2. Karaka Bay Wharf Section Detail

11.2 Condition Assessment

11.2.1 Concrete Piers and Piles

The concrete piers shown in Figure 11-3 and Figure 11-4 showed rust staining, due to ongoing corrosion of bolted connection above, but otherwise were in a structural sound condition without any visible signs of distress such as cracking or spalling.



Figure 11-3. Karaka Bay Wharf – Concrete Abutment



Figure 11-4. Karaka Bay Wharf – Concrete Pier

All three underpinned intermediate piers including piles, bearers and connections were also found in a sound conditions, besides marine growth observed within the submerged and tidal zone. Refer to Figure 11-15.



Figure 11-5. Karaka Bay Wharf – Retrofitted Under Pinned Piers

Only the pier piles at the end pier were found to be in a poor condition, refer to Figure 11-6, comprising significant cross section loss due to rot and splitting.

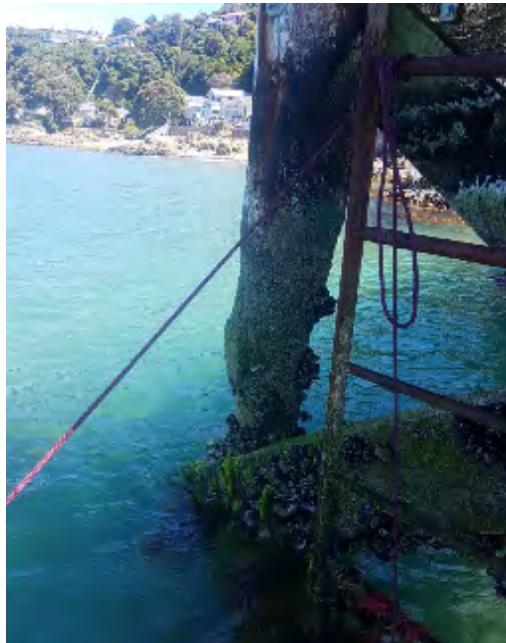

Figure 11-6. Karaka Bay Wharf – Pile at End Pier, C2

11.2.2 Bearers

The condition of bearers appeared to vary, with the bearers of the three intermediate timber piers having been replaced in more recent years. Refer to Figure 11-7. The other timber bearer at the 2nd concrete pier appeared

to show splitting and the onset of white rot which should be monitored in future inspections without need for immediate action.



Figure 11-7. Karaka Bay Wharf – Bearers of Underpinned Piers



Figure 11-8. Karaka Bay Wharf – Bearer End Splitting and Onset of White Rot

11.2.3 Joists

The condition of the joists varied in the extent of cross section loss. It was found that joists with extensive loss had been sistered to restore the original cross section of the affected joists. Refer to Figure 11-9.

The joists, which have not been sistered yet, are the joists in the end-span of the wharf. Refer to Figure 11-10. These joists also showed significant splitting at the ends. Therefore, it is recommended to sister these joists as well, as part of ongoing wharf maintenance.



Figure 11-9. Karaka Bay Wharf – Sistered Joists on Intermediate Spans



Figure 11-10. Karaka Bay Wharf – Joists in End Span



Figure 11-11. Karaka Bay Wharf – Splitting and Cross Section Loss in Existing Joists

11.2.4 Decking

The underside of the decking planks showed extensive mould which is expected given the environmental conditions. Refer Figure 11-12. Otherwise no other defects were encountered.



Figure 11-12. Karaka Bay Wharf – Underside of Decking

The decking surfacing, shown in Figure 11-13, was found to have cracked between individual decking planks, but still provided skid resistance for pedestrian traffic. It is recommended to renew the surfacing to also provide better environmental protection to the decking planks.



Figure 11-13. Karaka Bay Wharf – Top Side of Decking and Handrails

11.2.5 Bracing

The bracing at the end pier appeared to have been renewed in recent years and was found to be in a reasonable condition besides marine growth and mould. Refer to Figure 11-14.



Figure 11-14. Karaka Bay Wharf – Bracing at End Piles

11.2.6 Connections and Bolts

The bolted connections at the replacement underpinning displayed corrosion being not stainless steel, as shown in Figure 11-15. However, the corrosion is not as far advanced as for the other connections comprising fixings of handrail posts to joists and decking planks to joists and should continue to be replaced with stainless connections.



Figure 11-15. Karaka Bay Wharf – Bolted Connection of Underpinned Pier



Figure 11-16. Karaka Bay Wharf – Bolted Connections of Original Joists and Decking Planks

11.2.7 Handrails

The handrails and toe boards appeared overall to be well maintained, with rust staining observed resulting from ongoing corrosion of the bolted connections. Refer to Figure 11-17. Only localised rot at the toe plank fastening locations appeared to have formed localised pockets, as shown in Figure 11-18. It is recommended that once the depth of these pockets is more than 50% of the toe plank thickness, the affected planks are replaced.



Figure 11-17. Karaka Bay Wharf - Handrail



Figure 11-18. Karaka Bay Wharf – Handrail and Kick Board

11.3 Above Water Inspection Notes

Structure	Karaka Bay Wharf		
Date of Inspection	23/11/2017		
Time of Inspection	2:50		
Low Tide Time	1:45		
Grid Reference	Item Description	Condition Description	Condition Rating
A1 - B1	Bearer	Good condition	1
A1-B1	Piles	Marine growth in tidal zone	1
B1	Pile	Slight off-vertical tilt to pile.	
Grid A	Joist - outer	Significant end splitting and loss of cross section	3
	All deck beams (joists)	Rotting and loss of cross section	3
Grid C	Cross Bracing	Marine growth in tidal zone	1
C1, C2	Piles	Cross section loss 10-30%	3
A2-B2	Piles	Marine growth in tidal zone	1
A3-B3	Piles	Marine growth in tidal zone	
Grid 2 to 1	Outer joists	Significant surface damage to joists, splitting present	3
Grids 2 to abutment	Inner joists	Inner joist in reasonable condition - better protected against the elements than outer.	2
Grids C to 3	Decking	Rot and splitting at ends of planks. Significant decay present on under side.	3
1	Concrete pier	Good solid condition, some minor spalling present	1
1	Beam spanning top of concrete pier	Splitting at ends, surface weathering and rot present.	3
	Bolts (all)	Significant corrosion.	4
	Hand rails	Good condition.	1
	Deck surfacing	Chipseal in poor condition, crumbling and flaking at edges and joints	6
	Toe rail	Some old, some newer - splitting and weathering present.	1 to 2
Older joists have been splinted along full length by newer joists for strength.			

11.4 Underwater Inspection Notes

Table 11-1. Underwater Inspection Notes

Pile Number	Condition Rating	Pile Number	Condition Rating
1	2	B2	2
A1	2	B3	2
A2	2	B4	2
A3	2	C1	2
A4	2	C2	2
B1	2		

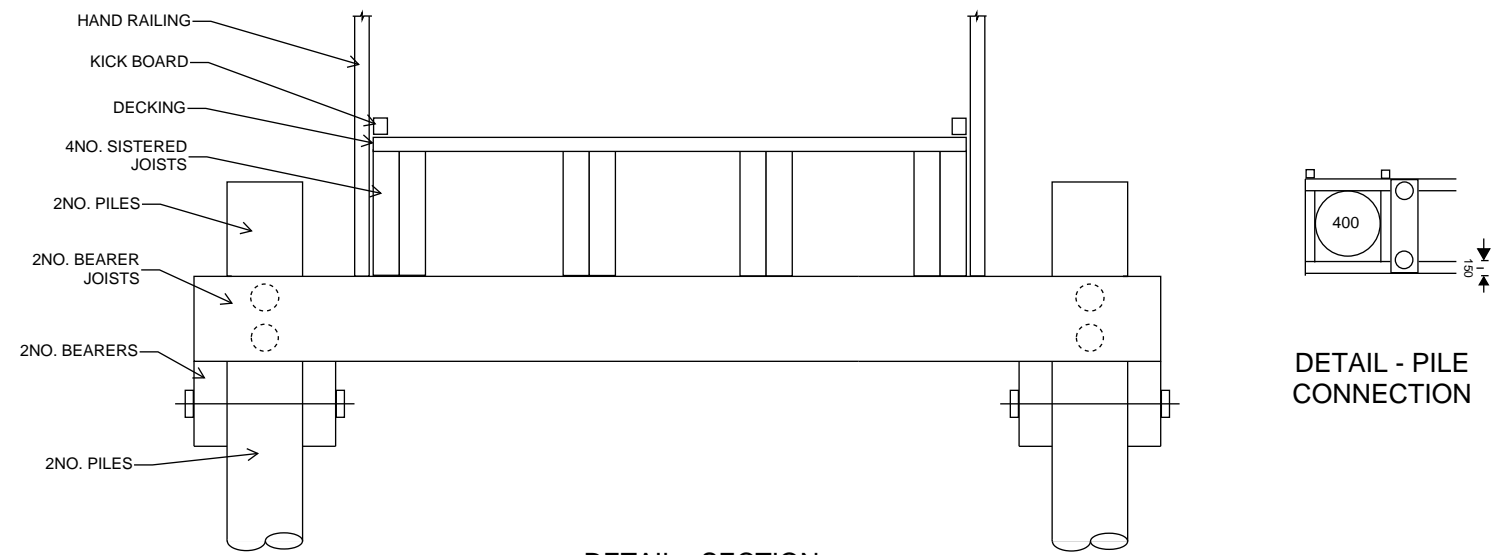

DETAIL - SECTION

DETAIL - PILE CONNECTION

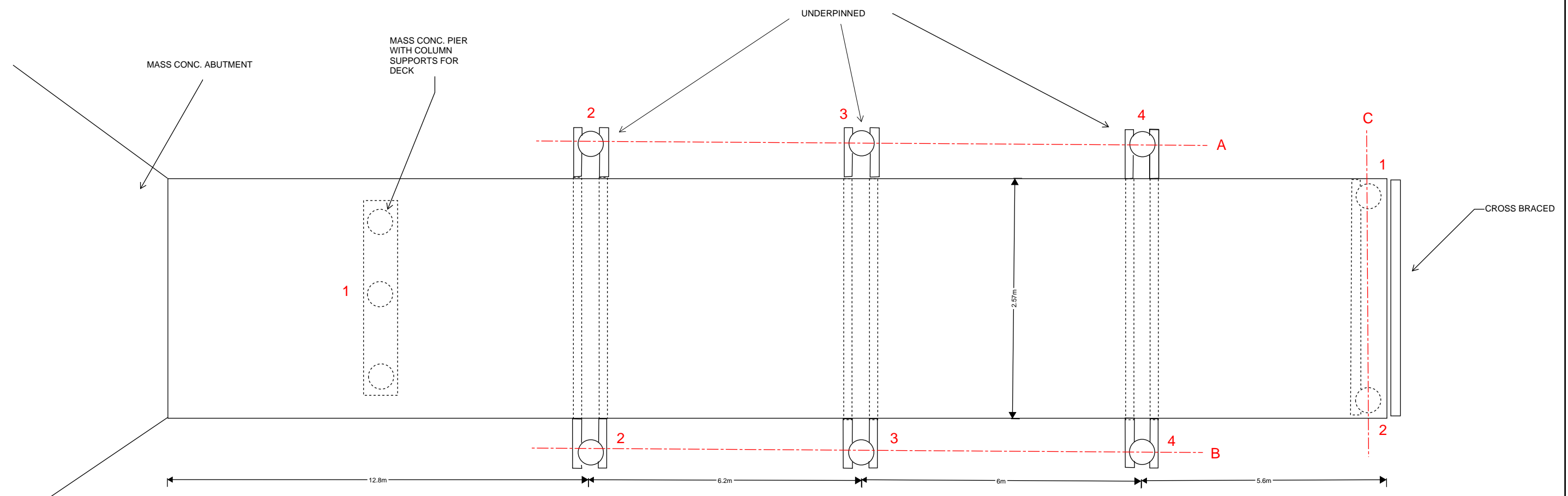

NOTES
 - handrails all along
 - not used for boats

PDF ONLY
NO DWG FILE

No.	Revision	By	Chk.	Appd.	Date
B	FOR INFORMATION			CP	11.17
A	FOR INFORMATION			CP	11.17



Original Scale (A1)	Design	Approved For Construction*
Reduced Scale (A3)	Drawn	Date
	Dwg Verifier	
	Dwg Check	
* Refer to Revision 1 for Original Signature		

Client: WELLINGTON CITY COUNCIL

Project: WCC WHARF STRUCTURAL INPSECTIONS

Title: KARAKA BAY WHARF

Discipline	MARINE STRUCTURAL
Drawing No.	3321525-SE-K106
Rev	B

Appendix A

Underwater Solutions' Pile
Inspection Report

WELLINGTON CITY COUNCIL MARINE ASSETS

INSPECTION REPORT

DECEMBER 2017



**UNDERWATER SOLUTIONS LTD
PO BOX 30 624
LOWER HUTT 5040
021 558 991**

Compiled by:

.....
Lee Steffens
Operations Manager

Approved by:

.....
Matt Fabish
Managing Director

INTRODUCTION

Underwater Solutions Ltd (UWS) were engaged by the Wellington City Council (WCC) to undertake inspections on several wharves and jetties around Wellington. The inspections undertaken throughout the month of November 2017, were under the direction of BECA Engineer representative/s.

PERSONNEL

The inspections were undertaken by the following personnel;

Diving Supervisor	Matt Fabish, HSE Part 4 Offshore Diver, NZ COC Part 3 and Supervisor
Inspection Diver	Dylan Spicer, ADAS Part 3 Diver, ADAS Supervisor, NZ COC Part 3
Inspection Diver	Chris Fabish, HSE & ADAS Part 4 Bell Diver, CSWIP Inspection Diver

WORK SCOPE

The sites to be inspected and work scope as below, was issued by BECA dated 15 November 2017;

- Greta Point Wharf
- Cog Park Boat Ramp
- Cog Park Jetty
- Evans Bay Yacht Club Finger Jetties (2no.)
- Evans Bay Yacht Club Travel Lift
- Evans Bay Boat Ramp Finger Jetties (2no.)
- Karaka Bay Wharf
- Seatoun Wharf

Each Pile was inspected and given a rating from 1 to 6 as per the BECA work scope.



RATING	DESCRIPTION
1	No visible damage / decay or minor damage with minor surface rot visible.
2	Less than 10% reduction in cross section from original. Some extent of rot visible.
3	10% - 30% reduction in cross section from original. Moderate extent of rot visible.
4	30% - 60% reduction in cross section from original. Extensive rot visible.
5	Greater than 60% reduction in cross section from original. Rot likely penetrated full cross section extent of pile.
6	Additional damage / decay not covered by condition ratings 1-5. Comments / notes included.





PHOTOGRAPHS



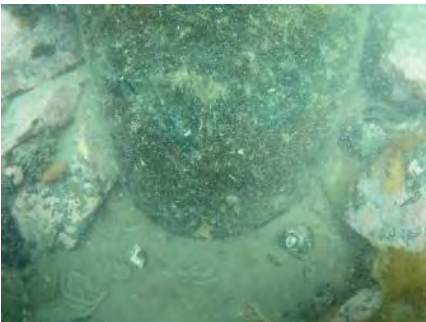

Reduced photographs of each pile are included in this report. Full resolution photographs are available at the following drop box link [here](#).



RESULTS

Greta Point Wharf

PILE #	RATING	COMMENTS	PHOTOGRAPH
1	1	Pile in near new condition.	
2	1	Pile in near new condition.	
3	1	Pile in near new condition.	
4	1	Pile in near new condition.	





5	1	Pile in near new condition.	
6	1	Pile in near new condition.	
7	1	Pile in near new condition.	
8	1	Pile in near new condition.	





9	1	Pile in near new condition.	
10	1	Pile in near new condition.	
11	1	Pile in near new condition.	
12	1	Pile in near new condition.	

13	1	Pile in near new condition.	
14	1	Pile in near new condition.	
15	1	Pile in near new condition.	
16	6	Not seen, covered in concrete pour.	

Cog Park Boat Ramp

PILE #	RATING	COMMENTS	PHOTOGRAPH
1	1	Top of pile wrapped with copper extending down 300 mm. Pile below copper in good condition.	





2	1	Top of pile wrapped with copper extending down 300 mm. Pile below copper in good condition.	
3	1	Top of pile wrapped with copper extending down 300 mm. Pile below copper in good condition.	
4	1	Top of pile wrapped with copper extending down 300 mm. Pile below copper in good condition.	
5	1	Top of pile wrapped with copper extending down 300 mm. Pile below copper in good condition.	



6	1	Top of pile wrapped with copper extending down 300 mm. Pile below copper in good condition.	
7	1	Top of pile wrapped with copper extending down 300 mm. Pile below copper in good condition.	
8	1	Top of pile wrapped with copper extending down 300 mm. Pile below copper in good condition.	
9	1	Top of pile wrapped with copper extending down 300 mm. Pile below copper in good condition.	

10	1	Top of pile wrapped with copper extending down 300 mm. Pile below copper in good condition.	
----	---	---	---

Cog Park Jetty



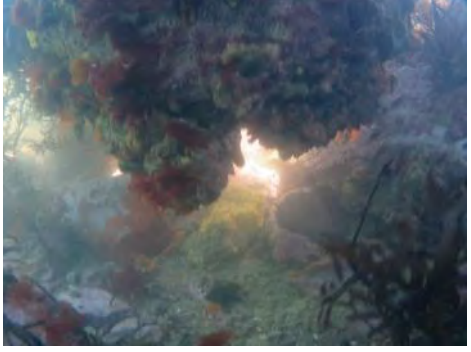

PILE #	RATING	COMMENTS	PHOTOGRAPH
1	3	Pile cased in concrete 250 mm thick. Jacket approx. 800 mm long. Pile not seen below jacket.	
2	3	Timber decaying around bolt. 15% - 20% loss of cross section.	
3	5	Hollowing / cavity around bolt hole. 80-90% loss of cross section. Diver could feel inside the cavity and only a thin wall remaining around the pile.	





4	2	Vertical splitting around pile.	
5	1	Timber pile in good condition.	
6	4	Deep vertical splitting around pile, approx. 40% loss of cross section.	
7	3	Vertical splitting 20 – 30 mm deep around pile.	





8	4	Cavity in tidal zone. 40-50% reduction in cross section.	
9	5	Pile cased in concrete jacket approx. 500 mm long, 250 mm thick. Pile / jacket "floating" with no foundation, approx. 300 mm free space under pile.	
10	6	Pile encased in concrete approx. 1000 mm long, 250 mm thick. Pile does not protrude out bottom of jacket. Concrete jacket is partially floating with 50 % of concrete jacket sitting on rock armouring, but not keyed into rock armouring.	

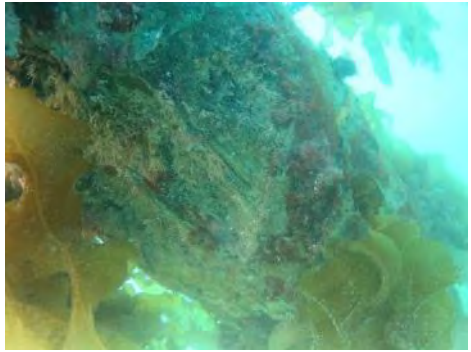



Evans Bay Yacht Club Finger Jetty – North

PILE #	RATING	COMMENTS	PHOTOGRAPH
1	1	Timber pile in good condition.	

2	3	Average condition, moderate decay.	
3	2	Timber pile in good condition.	
4	1	Timber pile in good condition.	
5	3	Vertical splitting in pile.	

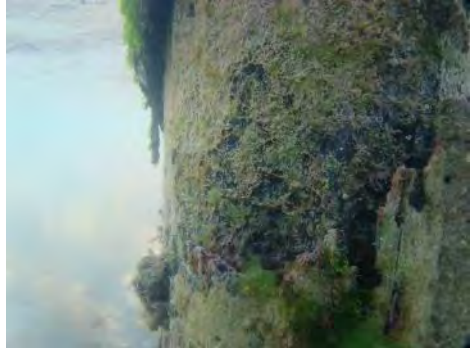
6	1	Copper wrapped, no timber exposed. Solid and appeared in good condition.	
7	1	Copper wrapped, no timber exposed. Solid and appeared in good condition.	
8	2	Average condition, minor decay.	
9	3	Concrete jacket around timber pile. 4 metres down from the top of pile to seabed. Concrete in good condition. Pile above jacket rated 3, with vertical splitting.	





10	5	Pile hollow at waterline. Only thin wall remaining around outside of pile.	
11	5	Pile hollow at seabed. Over 80% of original cross section depleted.	
12	3	Timber pile with vertical splitting.	
13	2	Timber pile in good condition.	



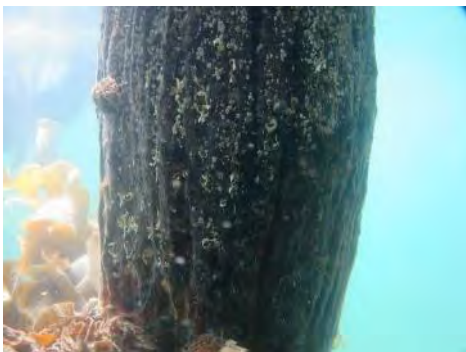
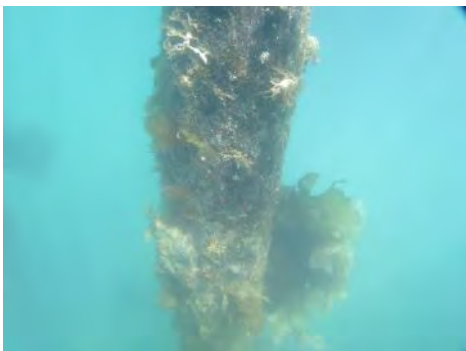

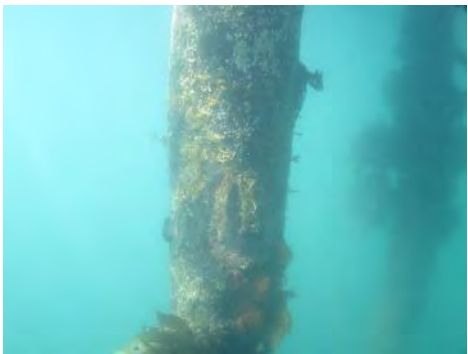
14	3	Timber pile, outside layer around pile decayed.	
15	2	Timber pile in good condition.	
16	3	<p>Note – Free standing mooring rope pile only. This pile was inspected on 14th March, post the main inspection.</p> <p>Timber pile had been copper wrapped. The copper had broken down with approximately 50% remaining. Some rot found on the exposed timber areas. Worst area of rot was 50 mm deep into the pile, 250 mm high and 150 mm wide (shown in photograph).</p>	
17	3	<p>Note – Free standing mooring rope pile only. This pile was inspected on 14th March, post the main inspection.</p> <p>Timber pile with vertical splitting.</p>	

18	3	<p>Note – Free standing mooring rope pile only. This pile was inspected on 14th March, post the main inspection.</p> <p>Timber pile with vertical splitting.</p>	
----	---	---	---

Evans Bay Yacht Club Finger Jetty – South

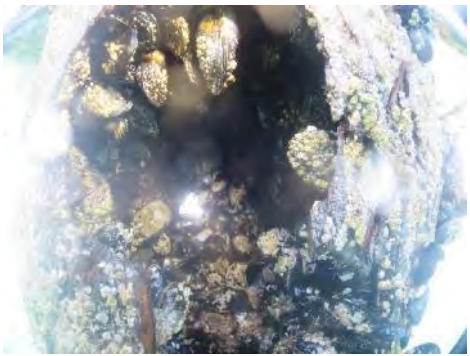

PILE #	RATING	COMMENTS	PHOTOGRAPH
1	2	Timber pile in good condition.	
2	2	Timber pile in good condition.	
3	2	Timber pile in good condition.	

4	2	Timber pile in good condition.	
5	2	Timber pile in good condition.	
6	2	Timber pile in good condition.	
7	2	Timber pile in good condition.	

8	5	Pile hollow at waterline. Cavity formed inside pile which had filled with mussels. Over 80% loss of cross section.	
9	2	Timber pile in good condition.	
10	2	Timber pile in good condition.	
11	2	Timber pile in good condition.	

12	3	Crack extending 30% - 40% into pile, approx. 1.5 metres long.	
----	---	---	---



Evans Bay Yacht Club Travel Lift





PILE #	RATING	COMMENTS	PHOTOGRAPH
1 - 8	6	All piles were steel pile showing signs of corrosion. Pitting in steel up to 5 mm deep.	 <p data-bbox="1209 1352 1294 1384">REF: 1</p>  <p data-bbox="1209 1809 1294 1841">REF: 2</p>





REF: 3

Evans Bay Boat Ramp Finger Jetty - North





PILE #	RATING	COMMENTS	PHOTOGRAPH
1	1	Timber pile in near new condition.	
2	1	Timber pile in near new condition.	
3	1	Timber pile in near new condition.	

4	1	Timber pile in near new condition.	
5	1	Timber pile in near new condition.	
6	1	Timber pile in near new condition.	
7	1	Timber pile in near new condition.	





8	1	Timber pile in near new condition.	
9	1	Timber pile in near new condition.	
10	1	Timber pile in near new condition.	



Evans Bay Boat Ramp Finger Jetty - South

PILE #	RATING	COMMENTS	PHOTOGRAPH
1	1	Timber pile, good condition.	
2	3	Timber pile in average condition, moderate decay.	
3	1	Timber pile, good condition.	





4	3	Vertical splitting in pile, deepest crack found at the waterline and measured 50 mm into pile.	
5	3	Timber pile in average condition, moderate decay.	
6	2	Timber pile in good condition with minor vertical splitting.	
7	1	Timber pile in good condition (smaller diameter pile).	

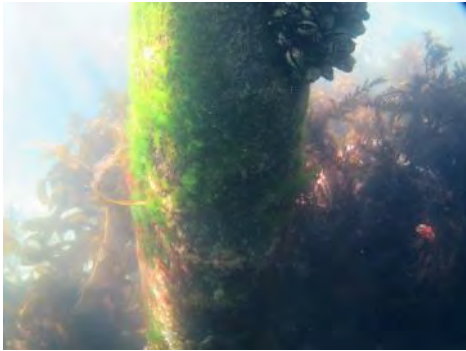



Karaka Bay Wharf

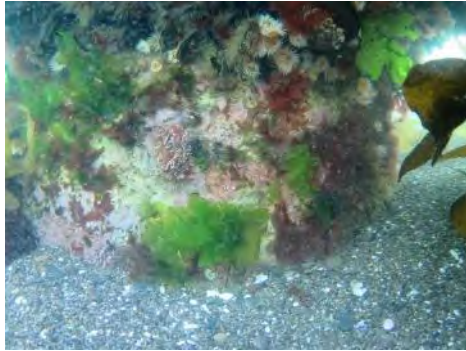

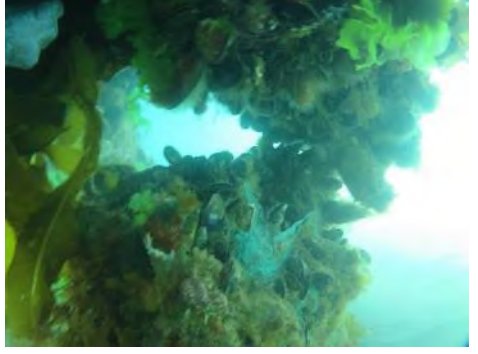

PILE #	RATING	COMMENTS	PHOTOGRAPH
1	N/A	Concrete – above water.	
A2	2	Timber in good condition.	
A3	2	Timber in good condition.	
A4	2	Timber in good condition.	
C1	2	Timber in good condition.	

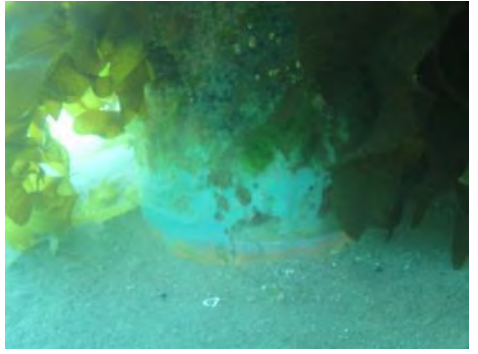

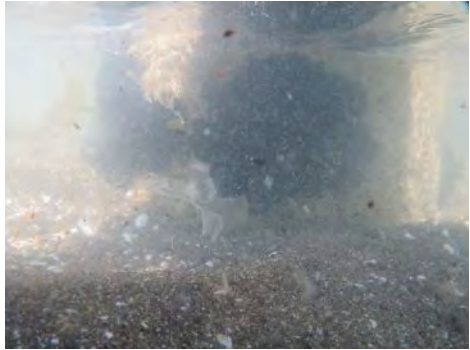

C2	2	Timber in good condition.	
B4	2	Timber in good condition.	
B3	2	Timber in good condition.	
B2	2	Timber in good condition.	





Seatoun Wharf





PILE #	RATING	COMMENTS	PHOTOGRAPH
A1		Pile above waterline.	N/A
A2		Pile above waterline.	N/A
A3		Pile above waterline.	N/A
A4	1	Pile encased in concrete approx. 250 mm thick.	
A5	2	Pile encased in concrete approx. 250 mm thick. Concrete has scoured on seaward side, exposing timber pile. Visible pile in good condition.	
A6	1	Pile encased in concrete approx. 250 mm thick.	
A7	2	Pile encased in concrete 100-300 mm thick. Pile exposed at seabed and in good condition	





A8	5	Pile broken through just below waterline. 100 mm gap between upper and lower pile sections.	
A8a	1	Timber pile in good condition.	
A9	1	Timber pile in good condition.	
A10	2	Timber pile in good condition.	

B1		Pile above waterline.	N/A
B2		Pile above waterline.	N/A
B3	2	Pile encased in concrete approx. 200 mm thick. Concrete scoured on seaward side.	
B4	2	Pile encased in concrete approx. 200 mm thick. Concrete scoured on seaward side.	
B5	3	Pile encased in concrete approx. 200 mm thick. Concrete scoured on seaward side. Timber pile exposed at seabed.	
B6	1	Pile encased in concrete approx. 250 mm thick.	

B7	2	Pile encased in concrete. Timber pile exposed under concrete and in good condition. Blocks and straps from repair visible.	
B8	1	Pile encased in concrete. Uneven thickness around pile. Good condition.	
B9	4	Hole at waterline. Remaining pile in good condition	
B10	2	Timber pile in good condition underwater. Some splitting above the waterline.	

B11	2	Timber pile in good condition.	
C1	2	Timber pile in good condition.	
C2	2	Timber pile in good condition.	
C3	2	Timber pile in good condition.	

C4	5	Pile hollowed near waterline. Cavity 70 - 80% of original cross section.	
D1	2	Timber pile in good condition.	
D2		Timber pile in good condition.	
D3	2	Timber pile in good condition.	

D4	2	Timber pile in good condition.	
E1	2	Pile encased in concrete to seabed.	
E2	2	Pile encased in concrete to seabed.	
E3	5	Pile encased in concrete to waterline. Above the concrete jacket a cavity was found. 70-80% of original cross section depleted.	

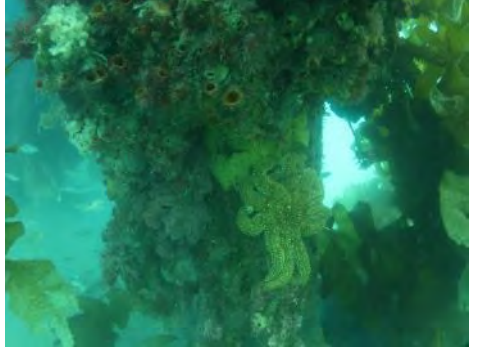
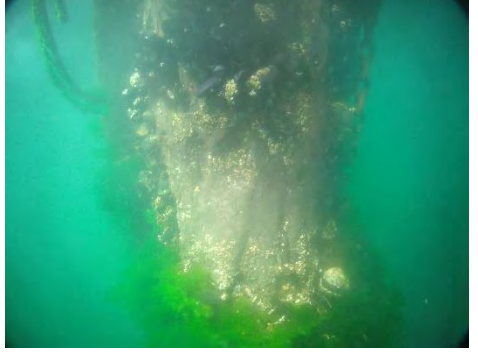
E4	3	Pile encased on concrete. The concrete jacket stopped 1 metre above the seabed. Pile below jacket rated 3.	
E4 Raker	3	Timber raker pile. Some minor damage from slack chain.	

RECOMMENDATIONS

- Undertake repairs to all piles rated 4 and 5.
- Install anodes on the steel piles on Travel lift piers.